

Application for resource consent or fast-track resource consent

(Or Associated Consent Pursuant to the Resource Management Act 1991 (RMA)) (If applying for a Resource Consent pursuant to Section 87AAC or 88 of the RMA, this form can be used to satisfy the requirements of Schedule 4). Prior to, and during, completion of this application form, please refer to Resource Consent Guidance Notes and Schedule of Fees and Charges — [both available on the Council's web page](#).

1. Pre-Lodgement Meeting

Have you met with a council Resource Consent representative to discuss this application prior to lodgement? Yes No

2. Type of Consent being applied for

(more than one circle can be ticked):

- Land Use
- Fast Track Land Use*
- Subdivision
- Consent under National Environmental Standard
(e.g. Assessing and Managing Contaminants in Soil)
- Other (please specify) _____
- Discharge
- Change of Consent Notice (s.221(3))
- Extension of time (s.125)

* *The fast track is for simple land use consents and is restricted to consents with a controlled activity status.*

3. Would you like to opt out of the Fast Track Process?

Yes No

4. Consultation

Have you consulted with Iwi/Hapū? Yes No

If yes, which groups have you consulted with?

Who else have you consulted with?

For any questions or information regarding iwi/hapū consultation, please contact Te Hono at Far North District Council tehonosupport@fndc.govt.nz

5. Applicant Details

Name/s:

Northland Regional Council

Email:

Phone number:

Postal address:

(or alternative method of service under section 352 of the act)

6. Address for Correspondence

Name and address for service and correspondence (if using an Agent write their details here)

Name/s:

Melissa McGrath

Email:

Phone number:

Postal address:

(or alternative method of service under section 352 of the act)

** All correspondence will be sent by email in the first instance. Please advise us if you would prefer an alternative means of communication.*

7. Details of Property Owner/s and Occupier/s

Name and Address of the Owner/Occupiers of the land to which this application relates (where there are multiple owners or occupiers please list on a separate sheet if required)

Name/s:

Far North District Council

**Property Address/
Location:**

Private Bag 752, Kaikohe, 0440

Postcode

8. Application Site Details

Location and/or property street address of the proposed activity:

Name/s:

**Site Address/
Location:**

Postcode

Legal Description:

Val Number:

Certificate of title:

Please remember to attach a copy of your Certificate of Title to the application, along with relevant consent notices and/or easements and encumbrances (search copy must be less than 6 months old)

Site visit requirements:

Is there a locked gate or security system restricting access by Council staff? Yes No

Is there a dog on the property? Yes No

Please provide details of any other entry restrictions that Council staff should be aware of, e.g. health and safety, caretaker's details. This is important to avoid a wasted trip and having to re-arrange a second visit.

9. Description of the Proposal:

Please enter a brief description of the proposal here. Please refer to Chapter 4 of the District Plan, and Guidance Notes, for further details of information requirements.

If this is an application for a Change or Cancellation of Consent Notice conditions (s.221(3)), please quote relevant existing Resource Consents and Consent Notice identifiers and provide details of the change(s), with reasons for requesting them.

10. Would you like to request Public Notification?

Yes No

11. Other Consent required/being applied for under different legislation

(more than one circle can be ticked):

- Building Consent
- Regional Council Consent (ref # if known)
- National Environmental Standard consent
- Other (please specify)

12. National Environmental Standard for Assessing and Managing Contaminants in Soil to Protect Human Health:

The site and proposal may be subject to the above NES. In order to determine whether regard needs to be had to the NES please answer the following:

Is the piece of land currently being used or has it historically ever been used for an activity or industry on the Hazardous Industries and Activities List (HAIL) Yes No Don't know

Is the proposed activity an activity covered by the NES? Please tick if any of the following apply to your proposal, as the NESCS may apply as a result. Yes No Don't know

- Subdividing land
- Changing the use of a piece of land
- Disturbing, removing or sampling soil
- Removing or replacing a fuel storage system

13. Assessment of Environmental Effects:

Every application for resource consent must be accompanied by an Assessment of Environmental Effects (AEE). This is a requirement of Schedule 4 of the Resource Management Act 1991 and an application can be rejected if an adequate AEE is not provided. The information in an AEE must be specified in sufficient detail to satisfy the purpose for which it is required. Your AEE may include additional information such as Written Approvals from adjoining property owners, or affected parties.

Your AEE is attached to this application Yes

13. Draft Conditions:

Do you wish to see the draft conditions prior to the release of the resource consent decision? Yes No

If yes, do you agree to extend the processing timeframe pursuant to Section 37 of the Resource Management Act by 5 working days? Yes No

14. Billing Details:

This identifies the person or entity that will be responsible for paying any invoices or receiving any refunds associated with processing this resource consent. Please also refer to Council's Fees and Charges Schedule.

Name/s: (please write in full)

Northland Regional Council (co Brendon Gray)

Email:

Phone number:

Postal address:

(or alternative method of service under section 352 of the act)

Fees Information

An instalment fee for processing this application is payable at the time of lodgement and must accompany your application in order for it to be lodged. Please note that if the instalment fee is insufficient to cover the actual and reasonable costs of work undertaken to process the application you will be required to pay any additional costs. Invoiced amounts are payable by the 20th of the month following invoice date. You may also be required to make additional payments if your application requires notification.

Declaration concerning Payment of Fees

I/we understand that the Council may charge me/us for all costs actually and reasonably incurred in processing this application. Subject to my/our rights under Sections 357B and 358 of the RMA, to object to any costs, I/we undertake to pay all and future processing costs incurred by the Council. Without limiting the Far North District Council's legal rights if any steps (including the use of debt collection agencies) are necessary to recover unpaid processing costs I/we agree to pay all costs of recovering those processing costs. If this application is made on behalf of a trust (private or family), a society (incorporated or unincorporated) or a company in signing this application I/we are binding the trust, society or company to pay all the above costs and guaranteeing to pay all the above costs in my/our personal capacity.

Name: (please write in full)

Brendon Gray

Signature:

(signature of bill payer)

Date 27-Aug-2024

MANDATORY

15. Important Information:

Note to applicant

You must include all information required by this form. The information must be specified in sufficient detail to satisfy the purpose for which it is required.

You may apply for 2 or more resource consents that are needed for the same activity on the same form. You must pay the charge payable to the consent authority for the resource consent application under the Resource Management Act 1991.

Fast-track application

Under the fast-track resource consent process, notice of the decision must be given within 10 working days after the date the application was first lodged with the authority, unless the applicant opts out of that process at the time of lodgement. A fast-track application may cease to be a fast-track application under section 87AAC(2) of the RMA.

Privacy Information:

Once this application is lodged with the Council it becomes public information. Please advise Council if there is sensitive information in the proposal. The information you have provided on this form is required so that your application for consent pursuant to the Resource Management Act 1991 can be processed under that Act. The information will be stored on a public register and held by the Far North District Council. The details of your application may also be made available to the public on the Council's website, www.fndc.govt.nz. These details are collected to inform the general public and community groups about all consents which have been issued through the Far North District Council.

15. Important information continued...

Declaration

The information I have supplied with this application is true and complete to the best of my knowledge.

Name: (please write in full)

Signature:

Date

A signature is not required if the application is made by electronic means

Checklist (please tick if information is provided)

- Payment (cheques payable to Far North District Council)
- A current Certificate of Title (Search Copy not more than 6 months old)
- Details of your consultation with Iwi and hapū
- Copies of any listed encumbrances, easements and/or consent notices relevant to the application
- Applicant / Agent / Property Owner / Bill Payer details provided
- Location of property and description of proposal
- Assessment of Environmental Effects
- Written Approvals / correspondence from consulted parties
- Reports from technical experts (if required)
- Copies of other relevant consents associated with this application
- Location and Site plans (land use) AND/OR
- Location and Scheme Plan (subdivision)
- Elevations / Floor plans
- Topographical / contour plans

Please refer to Chapter 4 of the District Plan for details of the information that must be provided with an application. Please also refer to the RC Checklist available on the Council's website. This contains more helpful hints as to what information needs to be shown on plans.

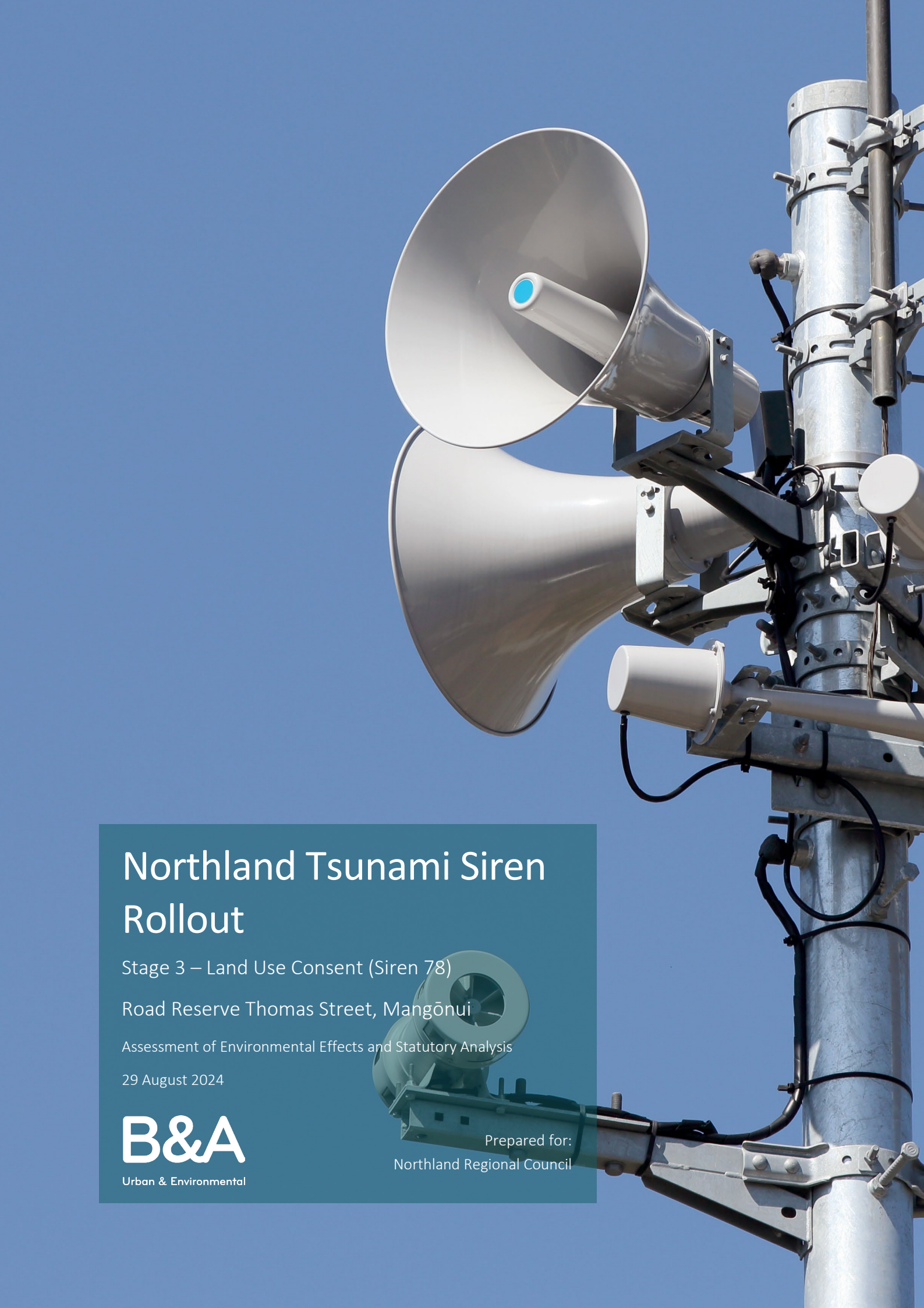

Northland Tsunami Siren Rollout

Stage 3 – Land Use Consent (Siren 78)

Road Reserve Thomas Street, Mangōnui

Assessment of Environmental Effects and Statutory Analysis

29 August 2024

B&A

Urban & Environmental

Prepared for:
Northland Regional Council

B&A Reference:

25380

Status:

Final Revision

Date:

29 August 2024

Prepared by:



Laura Bowman

Planner, Barker & Associates Limited

Reviewed by:



Melissa McGrath

Senior Associate, Barker & Associates Limited

Contents

1.0	Applicant and Property Details	5
2.0	Background	7
2.1	Pre-Lodgement Consultation	7
2.2	Consenting History	7
3.0	Site Context	8
3.1	Site Description and Locality	8
4.0	Proposal	9
5.0	Reasons for Consent	11
5.1	Operative Far North District Plan	12
5.2	Proposed Far North District Plan	12
5.3	National Environmental Standard – Contaminated Soils	12
5.4	Activity Status	12
6.0	Public Notification Assessment (Sections 95A, 95C and 95D)	13
6.1	Assessment of Steps 1 to 4 (Sections 95A)	13
6.2	Section 95D Statutory Matters	14
6.3	Land Excluded from the Assessment	14
6.4	Assessment of Effects on the Wider Environment	15
6.5	Summary of Effects	19
6.6	Public Notification Conclusion	19
7.0	Limited Notification Assessment (Sections 95B, 95E to 95G)	20
7.1	Assessment of Steps 1 to 4 (Sections 95B)	20
7.2	Section 95E Statutory Matters	21
7.3	Assessment of Effects on Adjacent Properties	21
7.4	Limited Notification Conclusion	23
8.0	Consideration of Applications (Section 104)	23
8.1	Statutory Matters	23
8.2	Weighting of Proposed Plan Changes: Proposed Far North District Plan	23
9.0	Effects on the Environment (Section 104(1)(A))	24
10.0	District Plan and Statutory Documents (Section 104(1)(B))	24
10.1	Objectives and Policies of the Far North District Plan	24
10.2	Objectives and Policies of the Proposed Far North Plan	25
10.3	Regional Policy Statement for Northland (RPS)	25
10.4	Objectives and Policies of the New Zealand Coastal Policy Statement	26
10.5	Summary	27
11.0	Part 2 Matters	27
12.0	Other Matters (Section 104(1)(C))	28
12.1	Record of Title Interests	28
13.0	Conclusion	28

Appendices

- Appendix 1: Email Correspondence and Engagement with Hapu
- Appendix 2: Email Correspondence and Engagement with Land Owner
- Appendix 3: Copy of Approved Resource Consent Decision – 2240061-RMALUC
- Appendix 4: Copy of Approved Resource Consent Decision – 2240307-RMALUC
- Appendix 5: Copy of Approved Resource Consent Decision – 2240382-RMALUC
- Appendix 6: Siren 78 – Site Plan
- Appendix 7: Siren 78 – Aerial Plan
- Appendix 8: Tsunami Siren Specifications
- Appendix 9: Elevation Plan
- Appendix 10: Noise Advice
- Appendix 11: ODP Rules Assessment
- Appendix 12: CDEM Tsunami Brochure 2023

1.0 Applicant and Property Details

To:	Far North District Council (FNDC)
Site Address:	Road Reserve Thomas Street, Mangōnui
Applicant Name:	Northland Regional Council
Address for Service:	Barker & Associates Ltd PO Box 37, Whangārei 0140 Level 1, 136 Bank Street Whangārei 0112 Attention: Melissa McGrath
Legal Description:	Parcel ID 5239227
Site Area:	3638m ²
Site Owner:	Far North District Council
District Plan:	Operative Far North District Plan (ODP) Proposed Far North District Plan (PDP)
Zoning:	ODP: Residential PDP: General Residential
Precinct:	ODP: None PDP: None
Overlays & Controls:	ODP: None PDP: Coastal Environment
Designations:	ODP: None PDP: None
Additional Limitations:	Adjacent to Heritage Area
Locality Diagram:	Refer to Figure 1
Brief Description of Proposal:	To construct and install a tsunami siren, including site preparation works and connection to power and telecommunication services in the Residential Zone. The project seeks to build resilience and support Te Taitokerau Northland's civil defence and emergency management response against tsunami risk.
Summary of Reasons for Consent:	ODP: Discretionary consent is required pursuant to Rules 7.6.5.1.4 Building Height, 7.6.5.1.5 Sunlight,

7.6.5.1.7 Setback from Boundaries and 7.6.5.1.15 Noise. A summary of reasons for consent is outlined in **Section 5** below.

2.0 Background

Northland Regional Council (**NRC**) is coordinating the rollout of new tsunami sirens across Te Taitokerau Northland. Barker & Associates (**B&A**) have been engaged to prepare and submit the resource consent application on behalf of NRC.

NRC is coordinating the siren roll out on behalf of all three-district councils within Te Taitokerau Northland. This project has been discussed in depth at Te Taitokerau's Civil Defence and Emergency Management Working Group (**CDEM**) and is fully supported by all iwi representatives, Council's CEO's and Mayors.

Currently, there are 205 sirens located throughout Te Taitokerau that do not meet the National Emergency Management Agency (**NEMA**) standards, the sirens do not meet frequency or messaging requirements of the standard and as such need replacing. 95 new sirens are proposed to replace the old sirens across Te Taitokerau which all have better coverage and will meet NEMA standards.

This proposal seeks to establish one new tsunami siren (siren 78) in the road reserve at the corner of Colonel Mould Drive and Thomas Street, Mangōnui. The siren infrastructure is part of CDEM's toolbox for managing the risk of tsunami across Te Taitokerau Northland. Details of pre-lodgement consultation and relevant consenting history are provided below.

The proposed siren infrastructure will be owned by FNDC, and managed by the Northland Regional Council (**NRC**).

This Assessment of Environmental Effects (**AEE**) has been prepared in accordance with the requirements of Section 88 of and Schedule 4 to the Resource Management Act 1991 (**RMA**) and is intended to provide the information necessary for a full understanding of the activity for which consent is sought and any actual or potential effects the proposal may have on the environment.

2.1 Pre-Lodgement Consultation

Records of consultation have been included within **Appendix 1** and **Appendix 2**.

2.2 Consenting History

2240061-RMALUC (**Stage 1**) was lodged on 03/08/2023, and sought consent to install 27 sirens proposed throughout the Far North District. Through the section 92 process, sirens 62, 63, 71, 76, 100 and 101 were removed from Stage 1. Sirens 63, 100 and 101 were sought as part of stage 2. Sirens 62, 71 and 76 were sought as a separate application. Stage 1 was approved on 18/12/2023 and resulted in the approval of a total of 21 sirens consented. Stage 1 is provided as **Appendix 3**.

2240307-RMALUC (**Stage 2 – Package 1**) was lodged on 19/01/2024, and sought consent to install eight sirens throughout the Far North District. Siren 103 was removed from Stage 2 and is being sought as a separate application within stage 3. Stage 2- Package 1 was approved on 19/04/2024 and resulted in the approval of a total of seven sirens consented. Stage 2- Package 1 is provided as **Appendix 4**.

2240382-RMALUC (**Stage 2 – Package 2**) was lodged on 19/03/2024, and sought consent to install nine sirens throughout the Far North District. Stage 2-Package 2 was approved on 10/05/2024 and

resulted in the approval of a total of nine sirens consented. Stage 2- Package 2 is provided as **Appendix 5**.

3.0 Site Context

3.1 Site Description and Locality

The proposed siren is located in the road reserve on Thomas Street, Mangōnui, near the corner with Colonel Mould Drive, as shown in **Figure 1** below. This is a small coastal settlement the west side of Mangōnui Harbour.

The site is approximately 3638m² and is sloped downward to the south east. The site is bounded on the north, east and west and southwest by the Residential Zone and the Commercial Zone to the southeast. Thomas Road is a narrow road with a formed carriageway width of approximately 5m. The formed carriageway on Thomas Street is approximately 20m long before it forms a 90m walkway called “Thomas Street Walkway” which connects to the remainder of Thomas Street to the southeast and around the coastal marine area.

Siren 78 is proposed on the northwest side of the road reserve, adjacent to 9 Colonel Mould Drive, in a grassed area that is raised slightly above the road level. There are existing overhead powerlines on the southern side of the road reserve on Colonel Mould Drive and a streetlight on the corner of Thomas Street and Colonel Mould Drive approximately 7m from the proposed siren 78 site.

The wider locality consists of primarily residential development, which makes up the settlement of Mangōnui with accommodation, retail outlets, takeaway outlets, restaurants and bar.



Figure 1: Locality plan

The site and location have been selected based on the following criteria:

- concentration of resident population;
- topography and sound propagation;
- availability of public land;
- access to a power supply and telecommunications; and
- serviceability.

In order for the siren to be effective, it is within coastal settlement or built-up area with resident populations. In addition to this and in order for the siren to function, it is required to be located near an electricity supply, be within cell tower coverage, and be easily accessed for ongoing maintenance.

4.0 Proposal

A summary of the key elements of the proposal is set out below. More detailed descriptions on particular aspects of the proposal are set out in the specialist reports and plans accompanying the application.

NRC are coordinating Te Taitokerau Northlands region wide roll out of new tsunami sirens to improve the regions emergency management response to the tsunami risk. This application includes the installation of one new siren within the road reserve. A site plan is included at **Appendix 6** and **Appendix 7** demonstrating the location of the siren within the site.

It is proposed to utilise HSS Engineering Warning System Solutions; see **Appendix 8** for specification details. The siren type will be TWS-295 and be mounted on an 8m height mast. See **Figure 3** below to see example of the tsunami siren. Details of the sirens are as follows:

- **Siren:**
 - Siren 78 is proposed as a TWS-295 siren and will have a maximum height of 9.8m. Refer Elevation Plans at **Appendix 9**.
 - **Foundation:** The siren mast/pole will be set within a precast concrete foundation that is 2.5m x 2.5m in area.
 - The siren is proposed to be painted in Resene's 'Resene Abbey cc' coded as B45-009-231, this colour has a Light Reflectance Value of approximately 15. Refer to **Figure 2** below.

Colour swatches online



- [Download instructions](#) -

Colour name:	Resene Abbey cc
Total colour code:	B45-009-231
Chart colour code:	3GR40
Tone:	Light
Colour palette:	Blue
RGB:	<input type="text" value="73"/> <input type="text" value="81"/> <input type="text" value="84"/>
Hex values:	#495154
LAB:	<input type="text" value="33.86"/> <input type="text" value="-2.48"/> <input type="text" value="-2.85"/>
CMYK:	<input type="text" value="13"/> <input type="text" value="4"/> <input type="text" value="0"/> <input type="text" value="67"/>
Approx. LRV:	<input type="text" value="15"/>
Colour pencil recipe:	<input type="text" value="155"/> <input type="text" value="234"/> <input type="text" value="-"/> <input type="text" value="-"/>

Figure 2: Proposed structure colour

- Bi-annual Tsunami Siren Testing:** The sirens will be tested twice annually at the turn of day light savings. As per 2240061-RMALUC, the following conditions are offered to manage the effects of the bi-annual warning system testing:

 - The tsunami siren may be tested twice a year at the turn of daylight savings. Each test shall be undertaken for a maximum duration of two minutes during the daytime. Testing of the sirens shall not occur at night.*
- Earthworks:** Approximately 3.5m³ of earthworks are proposed over an area of 6.5m² is proposed for each siren to establish a foundation pad which is 2.5m x 2.5m. No vegetation removal is required.
- Construction staging:** The estimated construction timeframe is 10 days, including to form the platform, install the concrete block foundation, install the mast, mount the siren, and connect the power supply.

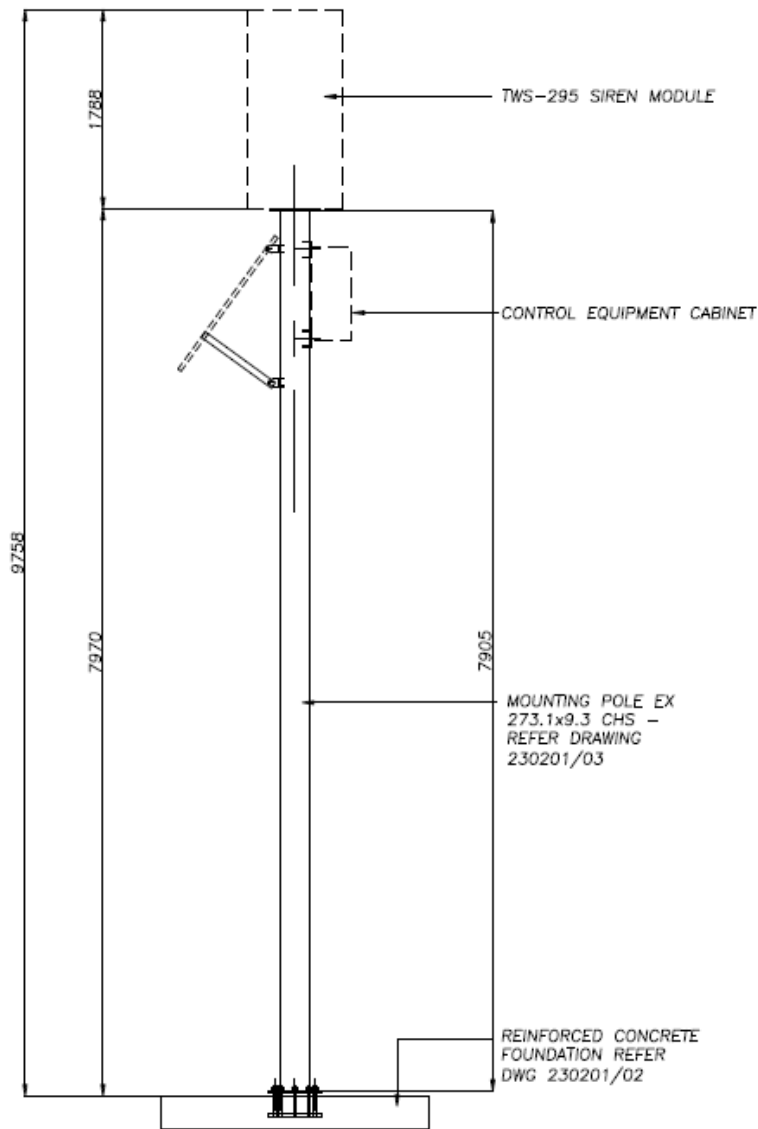

GENERAL ARRANGEMENT – TWS-295 SIREN
1:50

Figure 3: Elevation Plan of Proposed Siren 78

Detail of each element described above is provided in the relevant reports or plans.

5.0 Reasons for Consent

A rules assessment against the provisions of the **ODP** is attached as **Appendix 11**. The site is The site is located within the Residential Zone under the Operative District Plan and General Residential Zone with a Coastal Environment overlay under the Proposed District Plan . The proposal requires consent for the matters outlined below.

5.1 Operative Far North District Plan

Residential Zone

- **7.6.5.1.4 Building Height** - The proposed siren is 9.8m in height exceeding the permitted limit of 8m, being a discretionary activity in accordance with rule 7.6.5.1.4.
- **7.6.5.1.5 Sunlight** - The proposed siren is setback 3m setback from the site boundary and will project beyond a 45 degree recession plane when measured 2m inwards exceeding the permitted limit, being a discretionary activity in accordance with rule 7.6.5.1.5.
- **7.6.5.1.7 Setback from Boundaries** - The proposed siren within the road boundary and therefore infringes the permitted limit of 3m from a road boundary, being a restricted discretionary activity in accordance with rule 10.8.5.1.7.
- **7.6.5.1.14 Noise** - The proposed siren will infringe the permitted noise standard when the siren is operating, being a restricted discretionary activity in accordance with rule 10.8.5.1.14.

5.2 Proposed Far North District Plan

No rules with immediate legal effect trigger reasons for consent in accordance with section 96F of the RMA.

5.3 National Environmental Standard – Contaminated Soils

The NES Contaminated Soils were gazetted on 13th October 2011 and took effect on 1st January 2012.

The standards are applicable if the land in question is, or has been, or is more likely than not to have been used for a hazardous activity or industry and the applicant proposes to subdivide or change the use of the land, or disturb the soil, or remove or replace a fuel storage system.

Proposed Siren 78 is not mapped on Northland Regional Councils Selected Land Use register and there is no information that suggests that the site has been used for any activities that are on the Hazardous Activities and Industry List (HAIL) or evidence of migration of hazardous substances from adjacent land use.

Based on the above, the Resource Management (National Environmental Standard for Assessing and Managing Contaminants in Soil to Protect Human Health) Regulations 2011 (NES-CS) does not apply to the proposal.

5.4 Activity Status

Overall, this application is for a **discretionary activity**.

6.0 Public Notification Assessment (Sections 95A, 95C and 95D)

6.1 Assessment of Steps 1 to 4 (Sections 95A)

Section 95A specifies the steps the council is to follow to determine whether an application is to be publicly notified. These are addressed in statutory order below.

6.1.1 Step 1: Mandatory public notification is required in certain circumstances

Step 1 requires public notification where this is requested by the applicant; or the application is made jointly with an application to exchange of recreation reserved land under section 15AA of the Reserves Act 1977.

The above does not apply to the proposal.

6.1.2 Step 2: If not required by step 1, public notification precluded in certain circumstances.

Step 2 describes that public notification is precluded where all applicable rules and national environmental standards preclude public notification; or where the application is for a controlled activity; or a restricted discretionary, discretionary or non-complying boundary activity.

In this case, the applicable rules do not preclude public notification, and the proposal is not a controlled activity or boundary activity. Therefore, public notification is not precluded.

6.1.3 Step 3: If not required by step 2, public notification required in certain circumstances.

Step 3 describes that where public notification is not precluded by step 2, it is required if the applicable rules or national environmental standards require public notification, or if the activity is likely to have adverse effects on the environment that are more than minor.

As noted under step 2 above, public notification is not precluded, and an assessment in accordance with section 95A is required, which is set out in the sections below. As described below, it is considered that any adverse effects will be less than minor.

6.1.4 Step 4: Public notification in special circumstances

If an application is not required to be publicly notified as a result of any of the previous steps, then the council is required to determine whether special circumstances exist that warrant it being publicly notified.

Special circumstances are those that are:

- Exceptional or unusual, but something less than extraordinary; or
- Outside of the common run of applications of this nature; or
- Circumstances which make notification desirable, notwithstanding the conclusion that the adverse effects will be no more than minor.

The application is to install one new tsunami siren at the road reserve on Thomas Street, Mangōnui, within the Far North District. Resource consent is required discretionary activity as such the ODP provides for and anticipates this activity on a case by case basis. The proposal infringes bulk and location controls for maximum height/setback/height in relation to boundary generating effects that are akin to a street light or 30kV power pole.

It is considered that there is nothing noteworthy about the proposal. It is therefore considered that the application cannot be described as being out of the ordinary or giving rise to special circumstances.

6.2 Section 95D Statutory Matters

In determining whether to publicly notify an application, section 95D specifies a council must decide whether an activity will have, or is likely to have, adverse effects on the environment that are more than minor.

In determining whether adverse effects are more than minor:

- Adverse effects on persons who own or occupy the land within which the activity will occur, or any land adjacent to that land, must be disregarded.

The land to be excluded from the assessment is listed in section 6.3 below.

- Adverse effects permitted by a rule in a plan or national environmental standard (the 'permitted baseline') may be disregarded.

In this case, under the ODP, there is no relevant permitted baseline as all sirens infringe the noise thresholds.

- Trade competition must be disregarded.

This is not considered to be a relevant matter in this case.

- The adverse effects on those persons who have provided their written approval must be disregarded.

No persons have provided their written approval for this proposal.

The sections below set out an assessment in accordance with section 95D, including identification of adjacent properties, and an assessment of adverse effects.

6.3 Land Excluded from the Assessment

In terms of the tests for public notification (but not for the purposes of limited notification or service of notice), the adjacent properties to be excluded from the assessment are shown in **Figure 3** below, and include:

- 6 Colonel Mould Drive and 2 Colonel Mould Drive (North);
- 1 Colonel Mould Drive, 5 Colonel Mould Drive and 10 Thomas Street, (East);
- 7 Thomas Street (South); and

- 9 Colonel Mould Drive (West)



Figure 3: Adjacent properties in relation to subject site. Source: Emaps.

6.4 Assessment of Effects on the Wider Environment

The following sections set out an assessment of wider effects of the proposal, and it is considered that effects in relation to the following matters are relevant:

- Natural Hazards;
- Noise;
- Construction Activities;
- Archaeological and Heritage Effects;
- Cultural Effects;
- Built Character and Amenity;
- Coastal Environment, Landscape and Visual Amenity; and
- Servicing.

These matters are set out and discussed below.

6.4.1 Natural Hazards

Siren 78 is not mapped by NRC as being subject to any Natural Hazards. This siren and the settlement that it is proposed within are in a coastal environment but the land in the area is slopes

upward from the coast and the proposed siren site is located above all identified coastal natural hazards.

For the reasons outlined above, adverse effects on the localised and wider environment are assessed as less than minor.

6.4.2 Noise

The proposed tsunami siren is anticipated to infringe the permitted noise thresholds within the ODP when activated. This is not unexpected given the purpose of the siren is to alert residents within the coastal settlement in the event of possible tsunami threat.

Acoustic Advice has been prepared by Marshall Day Acoustic Engineers (refer to **Appendix 10**) which estimates the distance that the noise thresholds may be exceeded. This is based on the projected noise emissions for each siren when activated. Marshall Day estimated noise levels will be exceeded during siren activation as follows:

- Day time testing: 50 dB L_{Aeq} will be exceeded when emitted from Residential, Rural or Coastal Zones for a distance of 1,400m during day time testing.
- Day time emergency: 50 dB L_{Aeq} will be exceeded when emitted from Residential, Rural, and Coastal Zones for a distance of 3,300m during a day emergency.
- Night time emergency: 45 dB L_{Aeq} will be exceeded when emitted from Residential, Rural, and Coastal Zones for a distance of 5,100m during a night time emergency.

While these thresholds are not site-specific propagation lines, they provide a useful comparison for how 'noisy' the proposed tsunami sirens will be during testing and in the during an emergency tsunami event. The noise emissions generated by the sirens during an emergency event while noisy are considered necessary. The proposed sirens are considered lifesaving infrastructure, designed to improve community resilience, readiness and response to the threat of tsunami risk.

In terms of frequency of noise exceedance, tsunami siren warnings are currently tested twice a year at the turn of daylight savings and it is intended to carry on this practice with the newly installed sirens. This testing, while operationally necessary, ensures the communities are familiar with the siren alerts and prompts good emergency evacuation practices within each community. It is designed to encourage communities to familiarise themselves with tsunami emergency evacuation practices and gathering points. To support this process, CDEM and NRC notify the public of these warning systems on their website. Given the infrequent nature of these tsunami warning and testing systems, effects on properties are considered to be temporary and experienced for a matter of minutes and overall acceptable.

Taking into account the above and the proposed restrictions to siren duration and frequency over the course of the year, the expert advice of Marshall Day Acoustic Engineers (see **Appendix 10**), adverse effects of the tsunami warning systems are managed to a level that is less than minor.

6.4.3 Construction Activities

Minimal earthworks are proposed to modify the site to enable the construction of the foundation pads for the masts to be installed, the TWS-295 will then be attached to the mast. No vegetation removal is proposed. Refer to the Tsunami Specifications included as **Appendix 8** for full details. This will include excavation of a maximum volume of 3.5m³ over an area of 6.5m² to establish suitable levels for the foundation pads.

During construction, it is proposed to install temporary sediment and erosion control measures to mitigate any potential adverse environmental effects as a result of the proposed land disturbance. Any adverse construction effects on the wider environment are considered to be less than minor as follows:

- It is anticipated that the construction works will be able to comply with the ODP construction noise and vibration standards having regard to the nature of the proposal. The duration of works and timeframes are estimated to take no more than 10 working days to install each siren. However, it is expected that a Construction Management Plan for the works will be outlined as required should a condition of consent be applied. It is considered that any adverse effects associated with construction noise and vibration would be temporary in nature, and are considered to be less than minor;
- It is anticipated that earthworks and construction will be carried out during standard construction hours, such that any adverse lighting effects on the wider environment are not anticipated; and
- There is sufficient space at all sites and within the surrounding road network to provide parking for construction vehicles. It is considered that any adverse construction traffic effects will be temporary and able to be appropriately managed. For works occurring within the road corridor, it is anticipated that a CAR and TMP will be provided prior to commencing construction.

Overall, having regard to the above, it is considered that any adverse construction effects will be less than minor.

6.4.4 Archaeological and Heritage Effects

An ArchSite search has been undertaken on the proposed siren site and no archaeology or heritage items within the site have been identified. While it is recognised that the proposed tsunami siren is located within the coastal environment and in proximity to the Mangōnuī Heritage Area where there is the potential for archaeology to exist, effects in this regard are considered to be less than minor for the following reasons:

- The proposal only involves approximately 3.5m³ over an area of approximately 6.5m², ensuring minimal disturbance of land;
- Taking into account the ArchSite assessment and overall physical works proposed, the probability of discovering archaeology is considered low;
- No sirens are proposed over known or recorded archaeological sites; and
- Should any archaeological material be encountered, typical accidental discovery protocols will be followed as set out in the Heritage New Zealand Pouhere Taonga Act 2014.

Taking into account the above, and recognising the accidental discovery protocols required under the Heritage New Zealand Pouhere Taonga Act 2014, adverse effects are assessed as less than minor.

6.4.5 Cultural Effects

The proposed tsunami siren 78 is not located within a site that is mapped as containing a site of significance to Māori in the ODP or PDP. While there are no known Māori values of importance in

this area, it is acknowledged that areas in proximity to the coast can hold importance to mana whenua.

In terms of potential impacts on waterways or the coastal marine area, the physical works associated with installing the infrastructure is considered minimal with temporary erosion and sediment control measures installed during the construction period to manage any runoff. No vegetation clearance is proposed as part at any of the sites. The proposed infrastructure does not impact access to the beach ensuring the access to mahinga kai will be maintained for mana whenua.

In terms of wider environment considerations, the proposed siren has been shared with Te Matarahurahu hapū, with written approval included within **Appendix 1**.

Taking the above into account, there are no known adverse effects on scheduled cultural heritage, sites of significance to Māori, or Māori cultural values.

6.4.6 Built Character and Amenity

The siren will not change the existing use of the site, instead, it will provide for the function and operation of a tsunami siren warning system that mitigates the risk of tsunami hazards in established populated community. The predominant use and nature of the land will remain the same.

The tsunami siren location has been carefully selected to maximise the range of the siren alert and acoustic propagation that ensures, in the event of a tsunami, the alert will reach the most people possible. The selection criteria have taken into account topography, access to power, telecommunications connections and availability of public land. Naturally, this location is within a coastal settlement where the risk of tsunami is present. Further to this, the proposed tsunami siren infrastructure intends to build of the Region-wide natural hazard resilience plan, meeting an operation and functional need within their proposed locations.

With respect to land disturbance, the proposed earthworks are minimal and temporary, with all exposed ground constructed over or regressed as required. Construction and earthworks effects are assessed in section 6.4.3 above and considered temporary and will be effectively managed to a level that is less than minor on wider environment amenity. Rural amenity and noise effects are assessed in section 6.4.2 above and also considered to be appropriately managed subject to conditions of consent.

The siren infrastructure does not have any associated intensity effects on wider environment amenity given they are managed remotely.

The proposed siren infrastructure, comprises a 2.5m² x 2.5m² foundation 8m height pole with a siren mounted to the top. It is proposed to install a siren type TWS-295 (1.78m (H) x 0.85m (W)), with a combined maximum height of 9.8m. The dimensions of the siren infrastructure are such that the GFA is not an issue.

This environment has been selected due to the resident populations that are established there. With respect to the built form and character, the siren is proposed to be located within an established coastal settlement with built form that can be characterised as coastal residential. Development in this area typically comprises single and double storey residential units with ancillary buildings that are setback from the road by 3m with boundary fencing and landscaped yards. There are overhead powerlines in the road reserve of Colonel Mould Drive and street

lighting at main intersections and by the public walkway that comes off Thomas Street. The proposed siren 78 infrastructure exceeds the height limits in this location however the siren is considered similar in nature to that of the existing overhead powerlines and lighting in the area.

Taking into account the scale and dimensions of the infrastructure and the nature of the built form in this location, the adverse effects are considered to be minimized to a level that is no more than minor.

6.4.7 Coastal Environment, Landscape and Visual Amenity

Siren 78 is located within an area that is subject to coastal environment overlay in the PDP, the siren is located within an existing coastal village which is comprised of existing built form and infrastructure. The combined height of the structures exceeds the maximum height, however, complies with the permitted standard GFA standards for buildings in all locations.

While the proposed siren infrastructure does not have a measurable GFA, the structure will exceed height limits within the coastal environment with the potential for generating adverse effects on the visual amenity and natural character values of the wider environment. The combined height of the structure will be approximately 9.8m however, when taking into account the dimensions of the siren, which is the largest component of the infrastructure, the effect on the wider environment is considered to be relatively modest. The structure will be visible; however, it is considered to be consistent with the overall built form of the wider environment and comparable to other critical infrastructure such as overhead powerlines or telecommunication infrastructure.

Further, the proposal is not considered to impact any access to the coastal environment.

6.4.8 Servicing

As mentioned above. The siren site has been chosen based on the topography and how the location will be able to service the new siren in terms of having access to better cellular and satellite coverage, and have access to solar and battery power. The siren location has been confirmed as suitable from a servicing perspective.

6.5 Summary of Effects

Overall, it is considered that any adverse effects on the environment relating to this proposal will be less than minor.

6.6 Public Notification Conclusion

Having undertaken the section 95A public notification tests, the following conclusions are reached:

- Under step 1, public notification is not mandatory;
 - Under step 2, public notification is not precluded;
 - Under step 3, public notification is not required as it is considered that the activity will result in less than minor adverse effects; and
 - Under step 4, there are no special circumstances.
- Therefore, based on the conclusions reached under steps 3 and 4, it is recommended that this application be processed without public notification.

7.0 Limited Notification Assessment (Sections 95B, 95E to 95G)

7.1 Assessment of Steps 1 to 4 (Sections 95B)

If the application is not publicly notified under section 95A, the council must follow the steps set out in section 95B to determine whether to limited notify the application. These steps are addressed in the statutory order below.

7.1.1 Step 1: Certain affected protected customary rights groups must be notified

Step 1 requires limited notification where there are any affected protected customary rights groups or customary marine title groups; or affected persons under a statutory acknowledgement affecting the land.

The above does not apply to this proposal.

7.1.2 Step 1: Certain affected protected customary rights groups must be notified

Step 2 describes that limited notification is precluded where all applicable rules and national environmental standards preclude limited notification; or the application is for a controlled activity (other than the subdivision of land).

In this case, the applicable rules do not preclude limited notification and the proposal is not a controlled activity. Therefore, limited notification is not precluded.

7.1.3 Step 3: If not precluded by step 2, certain other affected persons must be notified

Step 3 requires that, where limited notification is not precluded under step 2 above, a determination must be made as to whether any of the following persons are affected persons:

- In the case of a boundary activity, an owner of an allotment with an infringed boundary;
- In the case of any other activity, a person affected in accordance with s95E.

The application is not for a boundary activity, and therefore an assessment in accordance with section 95E is required and is set out below.

Overall, it is considered that any adverse effects on persons will be less than minor, and accordingly, that no persons are adversely affected.

7.1.4 Step 4: Further notification in special circumstances

In addition to the findings of the previous steps, the council is also required to determine whether special circumstances exist in relation to the application that warrant notification of the application to any other persons not already determined as eligible for limited notification.

In this instance, having regard to the assessment in section 6.1.4 above, it is considered that special circumstances do not apply.

7.2 Section 95E Statutory Matters

If the application is not publicly notified, a council must decide if there are any affected persons and give limited notification to those persons. A person is affected if the effects of the activity on that person are minor or more than minor (but not less than minor).

In deciding who is an affected person under section 95E:

- Adverse effects permitted by a rule in a plan or national environmental standard (the 'permitted baseline') may be disregarded;
- Only those effects that relate to a matter of control or discretion can be considered (in the case of controlled or restricted discretionary activities); and
- The adverse effects on those persons who have provided their written approval must be disregarded.

These matters were addressed in section 6.2 above, and no written approval have been obtained.

Having regard to the above provisions, an assessment is provided below.

7.3 Assessment of Effects on Adjacent Properties

Adverse effects in relation to amenity and character, dominance, shading and noise on persons are considered below.

Wider effects such as noise, construction activities, archaeological and heritage effects, cultural effects, built character and amenity, servicing and coastal environment were considered above, and considered to be less than minor.

7.3.1 Persons at 2 and 6 Colonel Mould Drive

The proposed siren 78 will be located 40m to the south east of the southern boundary of 6 Colonel Mould Drive and 27m to the south the boundary of 2 Colonel Mould Drive. This setback is such that it well complies with permitted sunlight and setback from boundary standards with respect to both sites. The proposed siren site is obscured from view of the residential units on the sites by the topography of the land and existing vegetation on their property. There are existing overhead powerlines along the southern side of the Colonel Mould Drive reserve, so the proposed structure will blend with the existing features in the locality. Due to the vegetation on the southern boundaries, and the separation and orientation of the residential units within 2 and 6 Colonel Mould Drive. It is considered that the proposed siren will not be discernible from either site. For these reasons it is considered that the proposal will have less than minor amenity effects on 2 and 6 Colonel Mould Drive.

7.3.2 Persons at 1 Colonel Mould Drive

The proposed siren 78 will be located 16m to the west of the boundary of 1 Colonel Mould Drive. This setback is such that it well complies with permitted sunlight and setback from boundary standards with respect to the site. 1 Colonel Mould Drive is occupied by the Mangōnui Motel which is oriented towards the north with views out over the Mangōnui harbour. The proposed siren 78 site is to be situated up hill and to the west of 1 Colonel Mould Drive and will not obstruct these harbour views. There are existing overhead powerlines along the southern side of the Colonel Mould Drive reserve and a streetlight on the corner of the intersection with Thomas Street, so the

proposed structure will blend with the existing features in the locality. Due to the separation distance and the orientation of the Motel Units on 1 Colonel Mould Drive. It is considered that the proposed siren will have less than minor amenity effects on 1 Colonel Mould Drive.

7.3.3 Persons at 5 Colonel Mould Drive and 10 Thomas Street

The proposed siren 78 will be located approximately 20m from the boundary of 5 Colonel Mould Drive and 40m from the boundary of 10 Thomas Street. This setback is such that it well complies with permitted sunlight and setback from boundary standards with respect to these sites. They are situated downhill from the proposed siren site to the northwest and are separated by Thomas Street. These sites are currently undeveloped but the proposed siren site will not obstruct harbour views of any potential development. There are existing overhead powerlines and a streetlight on the corner of the intersection in proximity to the proposed siren site, so the proposed structure will blend with the existing features in the locality. Due to the above it is considered that the proposed siren will have less than minor amenity effects on 5 Colonel Mould Drive and 10 Thomas Street.

7.3.4 Persons at 9 Colonel Mould Drive

The proposed siren 78 will be located approximately 3m from the boundary of 9 Colonel Mould Drive. This setback is such that it complies with permitted setback from boundary standards with respect to the site. This property is occupied by Saint Andrews Anglican Church and church graveyard. The proposed siren site is approximately 14m from the Church building, to the north east. There are existing overhead powerlines along the northern boundary of 9 Colonel Mould Drive. The intersection of Colonel Mould Drive and Thomas Road, which bounds the northeast boundary of 9 Colonel Mould Drive, contains a power pole and a streetlight. These are located approximately 12m and 8m from the proposed siren 78 site. So, the proposed structure will blend with the existing features in the locality. Due to the above it is considered that the proposed siren will have less than minor amenity effects on 9 Colonel Mould Drive.

7.3.5 Persons at 7 Thomas Street

The proposed siren 78 will be located approximately 37m from the boundary of 7 Thomas Street. This setback is such that it well complies with permitted sunlight and setback from boundary standards with respect to these sites. This site is situated downhill from the proposed siren site to the south. The proposed siren site is obscured from view of the residential unit by the topography of the land and existing vegetation on their property. Due to the separation, topography and vegetation of the residential unit within 7 Thomas Street. It is considered that the proposed siren will not be discernible the site. For these reasons it is considered that the proposal will have less than minor amenity effects on 7 Thomas Street.

7.3.6 Noise

The siren will exceed the permitted noise thresholds during an emergency alert and testing. As noted above, this testing regime will encourage and promote tsunami siren evacuation practice and familiarise communities with the warning signals associated with this activity. While it is recognised that these warning systems will be noisy, effects will be temporary and considered necessary to promote good CDEM practices. Taking into account the temporary nature of the noise exceedance, adverse effects on the properties and persons that experience the exceeded noise levels are considered less than minor. Taking into account the temporary nature of the noise

exceedance, adverse effects on the properties and persons that experience the exceeded noise levels are considered less than minor.

7.3.7 Summary of Effects

Taking the above into account, it is considered that any adverse effects on persons at the aforementioned properties will be less than minor in relation to amenity and character, dominance, shading and noise effects. Wider effects, were assessed above and are considered to be less than minor.

It is considered, therefore, that there are no adversely affected persons in relation to this proposal.

7.4 Limited Notification Conclusion

Having undertaken the section 95B limited notification tests, the following conclusions are reached:

- Under step 1, limited notification is not mandatory;
- Under step 2, limited notification is not precluded;
- Under step 3, limited notification is not required as it is considered that the activity will not result in any adversely affected persons; and
- Under step 4, there are no special circumstances.

Therefore, it is recommended that this application be processed without limited notification.

8.0 Consideration of Applications (Section 104)

8.1 Statutory Matters

Subject to Part 2 of the Act, when considering an application for resource consent and any submissions received, a council must, in accordance with section 104(1) of the Act have regard to:

- Any actual and potential effects on the environment of allowing the activity;
- Any relevant provisions of a national environmental standard, other regulations, national policy statement, a New Zealand coastal policy statement, a regional policy statement or proposed regional policy statement; a plan or proposed plan; and
- Any other matter a council considers relevant and reasonably necessary to determine the application.

As a discretionary activity, section 104B of the Act states that a council:

- (a) may grant or refuse the application; and
- (b) if it grants the application, may impose conditions under section 108.

8.2 Weighting of Proposed Plan Changes: Proposed Far North District Plan

On the 27th July Far North District Council (**FNDC**) notified their Proposed District Plan (**PDP**).

Under the Proposed Far North District Plan, siren 78 is zoned general residential and subject to Coastal Environment Overlay.

At the time of preparing this AEE, only rules identified as having immediate legal effect have been considered. This will remain the case until FNDC releases a decision on the Proposed Far North District Plan (this will occur once hearings have been completed).

9.0 Effects on the Environment (Section 104(1)(A))

Having regard to the actual and potential effects on the environment of the activity resulting from the proposal, it was concluded in the assessment above that any adverse effects relating to the proposal will be less than minor and that no persons would be adversely affected by the proposal.

Further, it is considered that the proposal will also result in positive effects including:

- The improved health and safety measures to support the wellbeing of coastal community at Te Hāpua ; and
- Improved civil defence and emergency management practices in Te Hāpua, designed to contribute to the regions civil defence and resilience to natural hazards within Te Taitokerau Northland; and
- Currently, the sirens do not achieve the minimum National Emergency Management Agency (NEMA) standards for tsunami sirens and alerts. The proposal will ensure Te Taitokerau Northland is in line with NEMA standards and best practice.

Overall, it is considered that when taking into account the positive effects, any actual and potential adverse effects on the environment of allowing the activity are acceptable.

10.0 District Plan and Statutory Documents (Section 104(1)(B))

10.1 Objectives and Policies of the Far North District Plan

10.1.1 Chapter 7.6 Residential Zone

The Residential Zone applies to areas that are predominantly residential, with typically medium density residential living, but are still compatible with the existing character and amenity of the area. The zone enables development while adhering to amenity standards designed to protect the special amenity values of residential sites.

The objectives and policies of chapter 7.6 seek to enable a wide range of activities, including the development of new residential areas where expansion would be sustainable, while outlining the protection of specific amenity values to ensure the protection of the special amenity values of residential sites.

Policy 7.6.4.5 specifies that non-residential activities are only allowed to be established within residential areas where they will not detract from the existing residential environment. The proposed siren infrastructure is considered to be relatively modest in scale and size when compared with a typical residential building that could otherwise be constructed within this

environment. The proposal involves minor land disturbance that will be appropriately managed and temporary. In terms of landscape and visual amenity, the proposed siren is considered to be acceptable within this location. Further, the infrastructure will be clustered with existing residential development and public infrastructure so as to contain the visual impacts of the activity within an already modified environment.

Overall, the siren infrastructure is considered to be consistent with intent of the Residential Zone.

10.2 Objectives and Policies of the Proposed Far North Plan

The proposal results in tsunami siren infrastructure being located within the General Residential Zone. The proposal also interreacts with the Coastal Environment overlay.

For the purposes of this application, the proposal has been categorised as a Temporary Activity, which is defined as follows:

“means an activity that is temporary and limited in duration. It may include carnivals; concerts; fairs; festivals and events; markets and exhibitions; public meetings; parades; special events; sporting events; filming activities; temporary military training activities; temporary motorsport activities; and emergency response training by ambulances, **Civil Defence, Coast Guard New Zealand, Fire and Emergency New Zealand, New Zealand Police, Land Search and Rescue, or Surf Life Saving New Zealand. It also includes buildings or structures accessory to temporary activities**, temporary car parking areas, and the ancillary activities associated with the temporary activities.”

The proposal has been categorised as an Emergency Service, which is defined as follows:

“Emergency Service, means ambulances, **Civil Defence, Coastguard New Zealand, Fire and Emergency New Zealand, New Zealand Police, Land Search and Rescue, and Surf Life Saving New Zealand.**”

While the above activity definition is the most appropriate, the PDP does not specifically provide for CDEM structures like tsunami sirens. However, it does provide for noise exemptions relating to emergency services. In the Noise Chapter, the noise rules and effects standards do not apply to:

“7. any warning device or siren used by emergency services for emergency purposes (and routine testing and maintenance)”

Overall, it is considered that there is a gap within the PDP with respect to CDEM service activities, which are considered fairly unique and uncommon in this context but are nonetheless important and required support the Regions civil defence and emergency management response. The proposed tsunami siren infrastructure is pivotal to the Region’s resilience plan for managing and addressing the risk of tsunami hazards within Te Taitokerau. Further, the proposal is considered to support the overall health, safety and wellbeing of the Region’s communities.

On this basis, the proposal is not considered to be contrary to, but is not entirely consistent with the anticipated outcomes of the PDP.

10.3 Regional Policy Statement for Northland (RPS)

The operative Regional Policy Statement (**RPS**) for Northland contains high level policy guidance for development within the region and is the vehicle for identifying and dealing with significant resource management issues in Te Taitokerau Northland. With respect to the coastal environment,

it contains objectives and policies which seek to protect and preserve the natural character of the coastal environment, whilst safeguarding the integrity, form, function and resilience of the coastal environment from natural hazards and protect significant indigenous biodiversity and habitats from inappropriate subdivision, use and development. Of particular relevance to this proposal are as follows:

- Objective 3.7 and 3.8 seek to provide for significant infrastructure that will protect health and safety of the community and recognise the importance of the long-term infrastructure.
- Objective 3.13 recognises the risk and impacts of natural hazard events. 3.13(b), (e) and (g) are of particular relevance to this proposal as they enable appropriate hazard mitigation measures to be constructed and recognise that critical infrastructure may have to be located within hazard prone areas.
- Policy 4.8 recognises that structures that have a functional need can be located within the coastal marine area and structures that will make a significant positive contribution to the local area or region.

In regards to above objectives and policies, the following is noted:

- The proposal is considered appropriate and a functional need for the reasons discussed throughout the assessment provided as part of this application.
- The tsunami sirens are a method that will mitigate coastal hazards such as tsunami by alerting the community and to ensure their safety.

On this basis, the proposal is considered to be consistent with outcomes of the RPS.

10.4 Objectives and Policies of the New Zealand Coastal Policy Statement

The New Zealand Coastal Policy Statement (**NZCPS**), prepared by the Minister of Conservation, sets out objectives and policies in order to achieve the purpose of the RMA in regards to the coastal environment of New Zealand. It contains objectives and policies which include those aimed at safeguarding the integrity, form, functioning and resilience of the coastal environment and sustaining its ecosystems, and preserving the natural character of the coastal environment.

Of particular relevance to this proposal are objectives 2, 4, 6 and policies 6, 13, 18, 19, 24 and 25 as follows:

Objective 2 and policy 13 seek to preserve the natural character, features, and landscape values of the coastal environment.

Objective 4 and policies 18 and 19 seek to maintain and enhance public open space within the coastal environment by ensuring public access to the coast is retained and provided for.

Objective 6 recognises that the protection of the values of the coastal environment does not preclude use and development in appropriate places and forms within appropriate limits, and that functionally some uses and development can only be located on the coast or in the marine area. Policy 6(2)(c) further acknowledges that there are activities with a functional need to be located in the coastal marine area.

Policies 24 and 25 seek to identify areas that are potentially to be affected by coastal hazards such as tsunami and how to avoid or mitigate them.

In regards to above objectives and policies, the following is noted:

The proposed siren site is not identified as an outstanding feature or landscape, and it has been established that any adverse effects on natural character will be less than minor.

The proposed activity does not restrict public access in any way.

The proposal is considered appropriate and have a functional and operational need to be located within the coastal environment for the reasons discussed throughout the assessment provided as part of this application.

The tsunami siren is a method that will mitigate coastal hazards such as tsunami by alerting the community and to ensure their safety. For the reasons noted above, it is considered that the proposal is aligned with the outcomes sought by the NZCPS.

10.5 Summary

It is considered that the proposed development is generally in accordance with the objectives and policies of the ODP, PDP, RPS and NZCPS.

11.0 Part 2 Matters

Section 5 of Part 2 identifies the purpose of the RMA as being the sustainable management of natural and physical resources. This means managing the use, development and protection of natural and physical resources in a way that enables people and communities to provide for their social, cultural and economic well-being and health and safety while sustaining those resources for future generations, protecting the life supporting capacity of ecosystems, and avoiding, remedying or mitigating adverse effects on the environment.

Section 6 of the Act sets out a number of matters of national importance including (but not limited to) the protection of outstanding natural features and landscapes and historic heritage from inappropriate subdivision, use and development.

Section 7 identifies a number of “other matters” to be given particular regard by Council and includes (but is not limited to) Kaitiakitanga, the efficient use of natural and physical resources, the maintenance and enhancement of amenity values, and maintenance and enhancement of the quality of the environment.

Section 8 requires Council to take into account the principles of the Treaty of Waitangi.

Overall, as the effects of the proposal are considered to be less than minor, and the proposal accords with the relevant ODP objectives and policies, it is considered that the proposal will not offend against the general resource management principles set out in Part 2 of the Act.

12.0 Other Matters (Section 104(1)(C))

12.1 Record of Title Interests

The Record of Title for the site is not subject to any interests.

13.0 Conclusion

The proposal involves the construction of one siren at the road reserve on Thomas Street, Mangōnui, within in the Far North District.

Based on the above report it is considered that:

- Public notification is not required as adverse effects in relation to noise, construction activities, archaeological and heritage effects, cultural effects, built character and amenity, servicing and coastal environment are considered to be less than minor;
- There are also positive effects including improving the resilience, health and safety of coastal communities in Mangōnui against tsunami risks;
- Limited notification is not required as no persons are considered to be adversely affected by the proposal;
- The proposal accords with the relevant ODP objectives and policies; and
- The proposal is considered to be consistent with Part 2 of the Act.

It is therefore concluded that the proposal satisfies all matters the consent authority is required to assess, and that it can be granted on a non-notified basis.

Laura Bowman

Subject: FW: Possible Mangōnui Tsunami Siren site.

Ngā mihi | Kind regards,

LAURA BOWMAN
Planner
027 361 7065
LauraB@barker.co.nz



barker.co.nz 

This email and any attachments are confidential. They may contain privileged information or copyright material. If you are not an intended recipient, please do not read, copy, use or disclose the contents without authorisation and we request you delete it and contact us at once by return email.

From: Papanui Polamalu <papanuip@nrc.govt.nz>
Sent: Tuesday, 27 August 2024 9:40 am
To: Brendon Gray <brendon.gray@nrc.govt.nz>
Subject: FW: Possible Mangōnui Tsunami Siren site.

From: Tiger Tukariri <tigertukariri@yahoo.co.nz>
Sent: Tuesday, August 27, 2024 7:03 AM
To: Papanui Polamalu <papanuip@nrc.govt.nz>
Subject: Re: Possible Mangōnui Tsunami Siren site.

Ae we the hapu tautoko the siren to be placed there at that site in Mangonui, also is great to hear Matua Te Warihi knowledge on things read the book the wild winds of the north awesome read gives the true accounts of why Hongi went there for and the reason for utu... Kia pai to ra ehoa

[Yahoo Mail: Search, organise, conquer](#)

On Mon, 26 Aug 2024 at 3:51 pm, Papanui Polamalu <papanuip@nrc.govt.nz> wrote:

Tēnā koe Tiger,

Oooooooh that's good kōrero there ehoa and interesting jingoos. Didn't know the kiore tails, one being Puhi and the other Tukiato. I'll try and remember to ask Papa Te Warihi about the kiore.

By the way, If we asked for permission to put the siren there, is that ok with you and the hapū???

Kia ora mai koe ehoa!!!

P.S. I asked Papa Te Warihi about Hongi and all his waka and he said your kōrero was right they carried them over whole so as not to waste time and get there fast!!!

From: Tiger Tukariri <tigertukariri@yahoo.co.nz>
Sent: Monday, August 26, 2024 2:11 PM
To: Papanui Polamalu <papanuip@nrc.govt.nz>
Subject: Re: Possible Mangōnui Tsunami Siren site.

Ka pai ehoa no I don't know anything about that area but the old court house down from that site is called Poroporo which means to cut in pieces because that where the Shark was caught and chopped up there by Tukiato the son of Moehuri and then he was banished from Mangonui to Taumarumaru and I've seen one of the Kiore that are carved on the meeting house at Ahipara Te Ohaki has 2 Rats the tale is Puhi and the long tale is Tukiato I'm not sure of the connection but the Carver was from My Hapu and both my Grandfathers were involved in that. So yeah ana Kia ora ano koe ehoa...

[Yahoo Mail: Search, organise, conquer](#)

On Mon, 26 Aug 2024 at 10:42 am, Papanui Polamalu

<papanuip@nrc.govt.nz> wrote:

Tēnā koe Tiger,

Firstly I wanted to thank you for taking time out from your day to meet with us, especially with your whānau needing you at that time, and showing us possible sites and giving us some kōrero about the choices.

Brendon has had a look at those sites and thinks this is the new proposed site (it's FNDC owned reserved).



Tsunami Siren # 78 - Mangonui

dated by spatialize.co.nz on 14/08/2024

Are we able to get your approval to use this site? Is there any kōrero that we may need for this place as well?

Ngā mihi nui ki a koe Tiger.

From: [Brendon Gray](#)
To: [Cushla Jordan](#); [Katie May](#); [Estee Rapatini](#)
Cc: [Bill Hutchinson](#); [Ruben Garcia](#)
Subject: RE: Last FNDC resource consents for Tsunami Sirens
Attachments: [image001.png](#)
[image006.png](#)
[image007.png](#)
[image008.png](#)
[image009.png](#)
[image010.png](#)
[image011.png](#)

Thanks Cushla,

Re: Koutu, yes absolutely can do. I'll advise the engineer to ensure it's as close to the fence as possible.

Re: Mangonui, we can move this within the site as required by roading. As per the Koutu one, we can push it further up by the fence line if required, or could slide it a little south to move it back from the bend/intersection a bit. We have the full support of the Hapu for this location (as we do for all of the sites).

Ngā mihi mahana

Brendon Gray

Emergency Management Specialist – Tsunami Projects

Northland Emergency Management Group » Te Kaunihera ā rohe o Te Taitokerau

Check out the Northland [Tsunami Siren Replacement Project here..](#)



P 0800 002 004 » [W www.nrc.govt.nz/civildefence/](http://www.nrc.govt.nz/civildefence/)



From: Cushla Jordan <cushla.jordan@fndc.govt.nz>
Sent: Tuesday, August 27, 2024 9:37 AM
To: Brendon Gray <brendon.gray@nrc.govt.nz>; Katie May <Katie.May@fndc.govt.nz>; Estee Rapatini <Estee.Rapatini@fndc.govt.nz>
Cc: Bill Hutchinson <Bill.Hutchinson@fndc.govt.nz>; Ruben Garcia <Ruben.Garcia@fndc.govt.nz>
Subject: FW: Last FNDC resource consents for Tsunami Sirens

Good Morning Brendon

As asset manager for roading, I am happy for these to proceed as follows:

Karikari Hall map (83) attached - [@Katie May](#) although this is road reserve the main purpose of this area is a reserve as there are toilets, picnic table and signage. Koutu Point map attached (105). If the siren can be located more against the fence line than within the berm area of road reserve.

Mangonui map attached (78). There are vacant sections at this location which could further develop, and I need to ensure there is enough room if roading were to condition owners with upgrading this section as per any potential future consents.

Rawhiti map attached (98). I am happy with this location.

Kind Regards

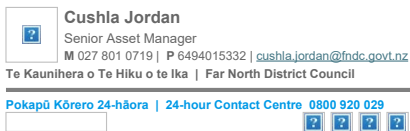

From: Katie May <Katie.May@fndc.govt.nz>
Sent: Monday, August 26, 2024 1:19 PM
To: Brendon Gray <brendon.gray@nrc.govt.nz>; Estee Rapatini <Estee.Rapatini@fndc.govt.nz>; Cushla Jordan <cushla.jordan@fndc.govt.nz>
Cc: Bill Hutchinson <billh@nrc.govt.nz>; Ruben Garcia <Ruben.Garcia@fndc.govt.nz>
Subject: RE: Last FNDC resource consents for Tsunami Sirens

Kia ora Brendan,

Thank you for the update, your maps look to be the same vintage as ours so was easy to match up locations! Please find below comments from myself on behalf of district facilities;

- Ramp Rd is in recreation reserve – as asset manager for recreation reserves, I am ok for this to proceed.
- Karikari Hall, Koutu Point and Mangonui are all road reserves and as such I have included [@Cushla Jordan](#) for comment.

Nga mihi,
Katie

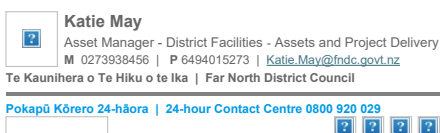

From: Brendon Gray <brendon.gray@nrc.govt.nz>
Sent: Thursday, August 22, 2024 10:47 AM
To: Estee Rapatini <Estee.Rapatini@fndc.govt.nz>; Katie May <Katie.May@fndc.govt.nz>
Cc: Bill Hutchinson <billh@nrc.govt.nz>; Ruben Garcia <Ruben.Garcia@fndc.govt.nz>
Subject: Last FNDC resource consents for Tsunami Sirens

CAUTION: This email originated from outside Far North District Council.
Do not click links or open attachments unless you recognise the sender and know the content is safe.

Kia ora koutou,

Can I please get FNDC's approval to use these sites as locations for new tsunami sirens?

Some of these are location changes for sites that FNDC had previously approved. We've had meetings with Hapu (primarily) and other community members, and have had to make some changes. These are all on FNDC owned land and this is to seek your approval as the landowner. These sites will all be going through the resource consent process, with the application (hopefully) being submitted next week.

S127					
Siren		Area	Latitude	Longitude	Change
83	293	Karikari Hall (now Whatuwhiwhi reserve)	-34.87523	173.38881	Was previously by the community hall, however Haititai Marangai Marae asked if we could move it closer to the marae, and they support this relocation.
105	293	Koutu Point	-35.473944	173.406124	Not enough width in previously approved location. Had to move further along roadside reserve to physically fit.
78	295	Mangonui	-34.98997	173.534996	Was previously approved in George St Reserve, however two Hapu do not approve of the location as they have claims against it. They support this relocation.
80	295	Ramp Road – Karikari (formerly Cable Bay)	-34.944837	173.383711	No change. New location.
98	295	Rawhiti Marae	-35.2315	174.2606	No change. New location.

Maps of each site are attached. Please forgive the age of the aerial photos.

Ngā mihi mahana

Brendon Gray

Emergency Management Specialist – Tsunami Projects

Northland Emergency Management Group » Te Kaunihera ā rohe o Te Taitokerau

Check out the Northland [Tsunami Siren Replacement Project here..](#)



P 0800 002 004 » W www.nrc.govt.nz/civildefence/



DECISION ON LAND USE CONSENT APPLICATION UNDER THE RESOURCE MANAGEMENT ACT 1991

Decision

Pursuant to section 34(1) and sections 104, 104B and Part 2 of the Resource Management Act 1991 (the Act), the Far North District Council **grants** land use resource consent for the following:

Council Reference:	2240061-RMALUC
Applicant:	Northland Regional Council
Property Address:	Long Beach Road, Russell 0202
Legal Description:	Sec 4 SO 364056
Description of Application:	To construct and install 21 Tsunami Sirens across the Far North District to Support Northland Civil Defence (CDEM) response to Tsunami Risk. Consent is required for a Discretionary Activity.

Conditions

Pursuant to sections 108 of the Act, this consent is granted subject to the following conditions:

General Conditions

1. The activity shall be carried out in accordance with the approved plans prepared by Northland Regional Council, referenced Northland Tsunami Siren Network, drawings numbered 230702/02 – 230703/15 dated 07/23, and attached to this consent with the Council's "Approved Stamp" affixed to them.

Pre Construction Conditions

2. Prior to the commencement of any physical work authorised under this consent, a Construction Management Plan ("CMP") shall be provided to Council's Engineer, or their delegated representative for certification.
3. Prior to the commencement of any physical work within the Council's road reserve, the Consent Holder shall submit a Corridor Access Request ("CAR") application, including a Traffic Management Plan/s, to the Northern Transportation Alliance Corridor Access Manager or delegated representative and obtain approval.
4. At least 30 working days prior to the commencement of construction works authorised as part of this resource consent, the consent holder shall submit a Temporary Traffic Management Plan (TMP) to the NTA Corridor Access Specialist for certification of the plan.

Earthworks conditions

5. The consent holder shall ensure stormwater diversion and silt control measures are in place in accordance with the Erosion and Sediment Control Guide for Land Disturbing Activities in the Auckland Region (GD05) prior to the commencement of earthworks. Photographic evidence of ESP measures being in place are to be emailed to FNDC Team Leader Monitoring and Compliance RCmonitoring@fndc.govt.nz referencing 2240061 – RMALUC.
6. The consent holder shall ensure that all earthwork operations are carried out in a way that reduces the risk of slope instability and soil erosion. To reduce and/or minimize any slope failures, effective mitigation measures must be constructed as needed.

Operational Conditions

7. The tsunami siren may be tested twice a year at the turn of daylight savings. Each test shall be undertaken for a maximum duration of two minutes during the daytime. Testing of the sirens shall not occur at night.

Advice Notes

Lapsing of Consent

1. *Pursuant to section 125 of the Act, this resource consent will lapse 5 years after the date of commencement of consent unless, before the consent lapses;*
 - a) *The consent is given effect to; or*
 - b) *An application is made to the Council to extend the period of consent, and the council decides to grant an extension after taking into account the statutory considerations, set out in section 125(1)(b) of the Act.*

Right of Objection

2. *If you are dissatisfied with the decision or any part of it, you have the right (pursuant to section 357A of the Act) to object to the decision. The objection must be in writing, stating reasons for the objection and must be received by Council within 15 working days of the receipt of this decision.*

Archaeological Sites

3. *Archaeological sites are protected pursuant to the Heritage New Zealand Pouhere Taonga Act 2014. It is an offence, pursuant to the Act, to modify, damage or destroy an archaeological site without an archaeological authority issued pursuant to that Act. Should any site be inadvertently uncovered, the procedure is that work should cease, with the Trust and local iwi consulted immediately. The New Zealand Police should also be consulted if the discovery includes koiwi (human remains). A copy of Heritage New Zealand's Archaeological Discovery Protocol (ADP) is attached for your information. This should be made available to all person(s) working on site.*

Reasons for the Decision

1. By way of an earlier report that is contained within the electronic file of this consent, it was determined that pursuant to sections 95A and 95B of the Act the proposed activity will not have, and is not likely to have, adverse effects on the environment that are more

than minor, there are also no affected persons and no special circumstances exist. Therefore, under delegated authority, it was determined that the application be processed without notification.

2. The application is for a Discretionary activity resource consent as such under section 104 the Council can consider all relevant matters.
3. In regard to section 104(1)(a) of the Act the actual and potential effects of the proposal will be acceptable as:
 - a. The permitted baseline is not relevant in this instance.
 - b. The receiving environment is as described in Section 3 of the notification assessment. There are no known granted but unimplemented consents of relevance to the application.
 - c. Access and traffic effects are less than minor as construction works will be short in duration and the safe operation of the roading network will be maintained during the works.
 - d. Adverse effects associated with landscape character and visual amenity values are less than minor due to the small footprint of the structures and that they will not result in domination, overshadowing or loss of privacy effects.
 - e. Overall, adverse effects associated with aural amenity values from construction the sirens are considered to be less than minor. However, adverse effects associated with aural amenity values from the operation of the sirens are considered to be minor given the testing proposed.
 - f. Effects on Cultural and Archaeological Values are less than minor
 - g. The proposal will also result in positive effects, including:
 - Provide for the safety for coastal communities across the Far North District;
 - Improve civil defence and emergency management practices within the District; and
 - The proposal will ensure Te Taitokerau Northland is in line with NEMA standards and best practice (which current sirens do not achieve).
4. In regard to section 104(1)(ab) of the Act there are no offsetting or environmental compensation measures proposed or agreed to by the applicant for the activity.
5. In regard to section 104(1)(b) of the Act the following statutory documents are considered to be relevant to the application:
 - a. New Zealand Coastal Policy Statement 2011,
 - b. Northland Regional Policy Statement 2016,
 - c. Operative Far North District Plan 2009,
 - d. Proposed Far North District Plan 2022

The activity is consistent with these documents for the reasons set out in pages 23- 25 of the Assessment of Environmental Effects submitted with the application. In particular:

New Zealand Coastal Policy Statement 2011 (NZCPS)

Of particular relevance to this proposal are the NZCPS objectives 2, 4, 6 and policies 6, 13, 18, 19, 24 and 25. The following comments are made in regards to the relevant objectives and policies:

- The sirens are predominately not identified as an outstanding feature or landscape, and it has been established that any adverse effects on natural character will be less than minor.
- The proposed activity does not restrict public access in any way.
- The proposal is considered appropriate and have a functional and operational need to be located within the coastal environment for the reasons discussed throughout the assessment provided as part of this application.
- The tsunami sirens are a method that will mitigate coastal hazards such as tsunami by alerting the community and to ensure their safety.

For the reasons noted above, it is considered that the proposal is aligned with the outcomes sought by the NZCPS.

Northland Regional Policy Statement 2016 (RPS)

Of particular relevance to this proposal are RPS objectives 3.7, 3.8, 3.13 and policy 4.8.

In regards to those objectives and policies, the following is noted:

- The proposal is considered appropriate and a functional need for the reasons discussed throughout the assessment provided as part of this application.
- The tsunami sirens are a method that will mitigate coastal hazards such as tsunami by alerting the community and to ensure their safety.

On this basis, the proposal is considered to be consistent with outcomes of the RPS.

Operative Far North District Plan

The proposal results in tsunami siren infrastructure being located within the General Coastal, Conservation, Coastal Living, Recreational Activities, Industrial, Residential, Coastal Residential, and Rural Living Zones.

Overall, it is considered that there is a gap within the ODP with respect to CDEM service activities and emergency services. Tsunami siren infrastructure is considered a fairly unique and uncommon in this context but are nonetheless important and required support the regions civil defence and emergency management response to the risk of tsunami hazards within the region.

Lifesaving infrastructure supports and provides for the health, safety and wellbeing of the communities of the Far North while appropriately managing effects on the localised and wider environment. While the ODP does not specifically provide for the proposed tsunami siren activity, it is considered that the proposal is not contrary to the anticipated outcomes of the ODP.

Proposed Far North District Plan

The proposal results in tsunami siren infrastructure being located within the Rural Production, Natural open space, Rural Lifestyle, Sport and Active Recreation, Settlement, Open Space, General Residential, and Rural Residential Zones. The proposal also interreacts with overlays that include the Coastal Environment, Coastal Flood Zone 1, 2 and 3, Notable Tree (36 and 141), River Flood Hazard 10- and 100-year ARI Event, Heritage Area – Part A – The Strand and Part C – Christ Church, High Natural Character (204 and 170), Treaty Settlement Area of Interest, Statutory Acknowledgement Area, Rāwene Heritage Area – Part B and Part A, and pedestrian frontage.

Overall, it is considered that there is a gap within the PDP with respect to CDEM service activities, which are considered fairly unique and uncommon in this context but are nonetheless important and required support the Regions civil defence and emergency management response. The proposed tsunami siren infrastructure is pivotal to the Region's resilience plan for managing and addressing the risk of tsunami hazards within Te Taitokerau. Further, the proposal is considered to support the overall health, safety and wellbeing of the Region's communities.

On this basis, the proposal is not considered to be contrary to, but is not entirely consistent with the anticipated outcomes of the PDP.

Weighting

For this resource consent application, the relevant provisions of both an operative and any proposed plan must be considered. Weighting is relevant if different outcomes arise from assessments of objectives and policies under both the operative and proposed plans.

As the outcomes sought are the same under the operative and the proposed plan frameworks, no weighting is necessary.

6. In regard to section 104(1)(c) of the Act there are no other matters relevant to the application.
7. Based on the assessment above the activity will be consistent with Part 2 of the Act.

The activity will avoid, remedy or mitigate any potential adverse effects on the environment while providing for the sustainable management of natural and physical resources and is therefore in keeping with the Purpose and Principles of the Act. There are no matters under section 6 that are relevant to the application. The proposal is an efficient use and development of the sites that will maintain existing amenity values without compromising the quality of the environment. The activity is not considered to raise any issues in regard to Te Tiriti o Waitangi.

8. Overall, for the reasons above it is appropriate for consent to be granted subject to the imposed conditions.

Approval

This resource consent has been prepared by Elisha Oldridge, Senior Planner. I have reviewed this and the associated information (including the application and electronic file material) and for the reasons and subject to the conditions above, and under delegated authority, grant this resource consent.

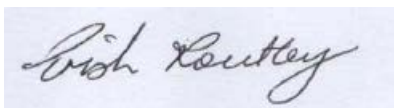

Patricia (Trish) Routley

Date: 18/12/2023

Manager Resource Consents

**DECISION ON LAND USE CONSENT APPLICATION
UNDER THE RESOURCE MANAGEMENT ACT 1991**

Decision

Pursuant to section 34(1) and sections 104, 104B, and 104D and Part 2 of the Resource Management Act 1991 (the Act), the Far North District Council **grants** land use resource consent, subject to the conditions listed below, to:

Applicant: Northland Regional Council

Council Reference: 2240307-RMALUC

Property Address:

Various

Legal Description	Siren #	Address	Legal Description
:	62	End of Tapeka Road, Russell	Lot 105 Deposited Plan 61184
	70	Matauri Bay Carpark, Matauri Bay Road	Lot 89 DP 393664 Road Way Block, Lot 189 DP 393664 Road Way and Lot 189 DP 39366
	71	Te Ngaere Toilets, Wainui Road	Lot 2 DP 48077
	76	Marlin Drive, Taupo Bay	Lot 117 DP 56267
	87	State Highway 1, Pukenui, Far North (opposite 4075 Far North Road)	Section 1 Survey Office Plan 6607311/68901
	89	Waipapakauri Beach Toilets, West Coast Road, Waipapakauri	Road reserve (Parcel ID 5236498)
	91	255 Foreshore Road, Ahipara, Kaitaia	Road Reserve (Parcel ID: 5237497)

The activities to which this decision relates are listed below:

To install and operate Tsunami Sirens at various locations across the Far North District.

Table 1: Siren 62: Conservation Zone

Rule Number and Name	Non Compliance Aspect	Activity Status
9.7.5.1.3 Building Height	The siren is proposed to be 9.123m high, this will infringe the permitted 8m height by 1.123m. As the siren is 9.123m high, this complies with the maximum height of 10m under the RDA rule.	Restricted Discretionary
9.7.5.1.6 Screening from neighbours	The sirens will not be screened, and no landscaping is proposed.	Restricted Discretionary
9.7.5.1.8 Noise	The siren will infringe the permitted noise threshold.	Restricted Discretionary
9.7.5.3 Discretionary Activities	The proposed siren is not directly for, or ancillary to, the principal conservation activities of the site in accordance with 9.7.5.1.1	Non-complying
12.7.6.1.1 Setback from Lakes, Rivers and the Coastal Marine Area	The siren will be approximately 14m from the CMA, infringing the permitted setback of 30m by 16m.	Non-complying

Table 2: Siren 70: General Coastal Zone (Outstanding Landscape)

Rule Number and Name	Non Compliance Aspect	Activity Status
10.6.5.1.5 Sunlight	The siren cannot comply with the HIRB and is setback 2.03m from the nearest boundary.	Restricted Discretionary
10.6.5.1.7 Setback from boundaries	The siren is 2.03m from the nearest site boundary, this cannot comply with the minimum setback of 10m. Therefore, infringes the rule by 7.97m.	Restricted Discretionary
10.6.5.1.10 Noise	The siren will infringe the permitted noise threshold	Restricted Discretionary
10.6.5.1.4 Building Height	The siren is proposed to be 9.123m high, this will infringe the permitted 8m height by 1.123m. As the siren is 9.123m high, this will also infringe the Restricted Discretionary Activity rule maximum height of 9m.	Discretionary

Table 3: Siren 71: Recreational Activities Zone (Outstanding Landscape)

Rule Number and Name	Non Compliance Aspect	Activity Status
9.6.5.1.3 Building Height	The siren is proposed to be 9.123m high, this will	Restricted

	infringe the permitted 8m height by 1.123m. As the siren is 9.123m high, this complies with the maximum height of 10m under the Restricted Discretionary Activity rule.	Discretionary
9.6.5.1.4 Sunlight	The siren cannot comply with the HIRB, the siren is setback 4.91m from the nearest boundary and is 9.123m height.	Restricted Discretionary
9.6.5.1.12 Noise	The siren will infringe the permitted noise threshold.	Restricted Discretionary
9.6.5.3 Discretionary Activities	The proposed siren is not directly for, or ancillary to, the principal recreation activities of the site in accordance with 9.6.5.1.1	Non-complying
12.7.6.1.1 Setback from Lakes, Rivers and the Coastal Marine Area	The siren will be approximately 22m from the CMA, infringing the permitted setback of 30m by 8m.	Discretionary

Table 4: Siren 76: Recreational Activities Zone

Rule Number and Name	Non Compliance Aspect	Activity Status
9.6.5.1.3 Building Height	The siren is proposed to be 9.123m high, this will infringe the permitted 8m height by 1.123m. As the siren is 9.123m high, this complies with the maximum height of 10m under the Restricted Discretionary Activity rule.	Restricted Discretionary
9.6.5.1.4 Sunlight	The siren cannot comply with the HIRB, the siren is setback 4.19m from the nearest boundary and is 9.123m height.	Restricted Discretionary
9.6.5.1.9 Screening for Neighbours	The sirens will not be screened, and no landscaping is proposed.	Restricted Discretionary
9.6.5.1.12 Noise	The siren will infringe the permitted noise threshold.	Restricted Discretionary
9.6.5.3 Discretionary Activities	The proposed siren is not directly for, or ancillary to, the principal recreation activities of the site in accordance with 9.6.5.1.1	Non-complying

Table 5: Siren 87: Conservation Zone

Rule Number and Name	Non Compliance Aspect	Activity Status
9.7.5.1.3 Building Height	The siren is proposed to be 9.123m high, this will infringe the permitted 8m height by 1.123m. As the siren is 9.123m high, this complies with the	Restricted Discretionary

	maximum height of 10m under the RDA rule.	
9.7.5.1.6 Screening from neighbours	The sirens will not be screened, and no landscaping is proposed.	Restricted Discretionary
9.7.5.1.8 Noise	The siren will infringe the permitted noise threshold.	Restricted Discretionary
9.7.5.3 Discretionary Activities	The proposed siren is not directly for, or ancillary to, the principal conservation activities of the site in accordance with 9.7.5.1.1	Non-complying
12.7.6.1.1 Setback from Lakes, Rivers and the Coastal Marine Area	The siren will be approximately 14m from the CMA, infringing the permitted setback of 30m by 16m.	Non-complying

Table 6: Siren 89: Recreational Activities Zone

Rule Number and Name	Non Compliance Aspect	Activity Status
9.6.5.1.3 Building Height	The siren is proposed to be 9.123m high, this will infringe the permitted 8m height by 1.123m. As the siren is 9.123m high, this complies with the maximum height of 10m under the Restricted Discretionary Activity rule.	Restricted Discretionary
9.6.5.1.9 Screening for Neighbours	The sirens will not be screened, and no landscaping is proposed.	Restricted Discretionary
9.6.5.1.12 Noise	The siren will infringe the permitted noise threshold.	Restricted Discretionary
9.6.5.3 Discretionary Activities	The proposed siren is not directly for, or ancillary to, the principal recreation activities of the site in accordance with 9.6.5.1.1	Non-complying

Table 7: Siren 91: Residential Zone (Te Tai Hauauru Statutory Acknowledgement Area)

Rule Number and Name	Non Compliance Aspect	Activity Status
7.6.5.1.4 Building Height	The siren is proposed to be 9.123m high, this will infringe the permitted 8m height by 1.123m. As the siren is 9.123m high, this will infringe the RDA rule maximum height of 9m.	Discretionary
7.6.5.1.8 Screening for Neighbours:	The sirens will not be screened, and no landscaping is proposed.	Restricted Discretionary
7.6.5.1.15 Noise	The siren will infringe the permitted noise threshold.	Restricted Discretionary

12.4.6.1.1 Coastal Hazard 2 Areas	The siren will be located within CHA 2 and no report has been provided so it will not meet the controlled activity status.	Discretionary
12.4.6.3.1 Coastal Hazard 1 Areas:	The siren will be located within CHA 1 and no report has been provided so it will not meet the discretionary activity status	Non-complying
12.7.6.1.1 Setback from Lakes, Rivers and the Coastal Marine Area	The siren will be approximately 15m from the CMA, infringing the permitted setback of 26m.	Non-complying

Conditions

Pursuant to sections 108 and 108AA of the Act, this consent is granted subject to the following conditions:

General Accordance Condition

1. The activity shall be carried out in general accordance with:
 - a) the approved plans prepared by prepared by Northland Regional Council, referenced Northland Tsunami Siren Network, drawings numbered 231203/02,05,09,16,19,31,33 and 34 dated 07/23, and attached to this consent with the Council's "Approved Stamp" affixed to it; and
 - b) all the supporting documents and additional information submitted with the application, detailed below, and all referenced by Council as 2240307-RMALUC:
 - i. Application form and Assessment of Environmental Effects prepared by Barker and Associates, dated 19 January 2024; and
 - ii. Siren Location Maps (Appendix 3 to the application) amended by the final response to further information; and
 - iii. Landscape and Visual Assessment prepared by Simon Cocker Landscape Architecture and dated 29 November 2023; and
 - iv. Construction Management Plan prepared by Tutakaka Consultants and approved by Council on 19 March 2023;
 - v. Interim response to further information requested prepared by Barker and Associates dated 19 March 2024, and
 - vi. Final response to further information prepared by Barker and Associates and dated 3 April 2024.
2. The sirens shall be located as follows, and as generally shown on the Siren Location Maps (Appendix 3 to the application referenced by Council as 2240307-RMALUC and amended by the final response to further information):

Siren #	Address	Legal Description
62	End of Tapeka Road, Russell	Lot 105 Deposited Plan 61184
70	Matauri Bay Carpark, Matauri Bay Road	Lot 89 DP 393664 Road Way Block, Lot 189 DP 393664 Road Way and Lot 189 DP 39366
71	Te Ngaere Toilets, Wainui Road	Lot 2 DP 48077
76	Marlin Drive, Taupo Bay	Lot 117 DP 56267
87	State Highway 1, Pukenui, Far North (opposite 4075 Far North Road)	Section 1 Survey Office Plan 6607311/68901
89	Waipapakauri Beach Toilets, West Coast Road, Waipapakauri	Road reserve (Parcel ID 5236498)
91	255 Foreshore Road, Ahipara, Kaitaia	Road Reserve (Parcel ID: 5237497)

Duration of Consent

3. Under section 125 of the RMA, this consent lapses five years after the date it is granted unless:
 - a. The consent is given effect to; or
 - b. The council extends the period after which the consent lapses.

Prior to Commencement of Construction/ Physical Works

4. Prior to the commencement of any physical work within the Council's road reserve, the Consent Holder shall submit a Corridor Access Request ("CAR") application, including a Traffic Management Plan/s, to the Northern Transportation Alliance Corridor Access Manager or delegated representative and obtain approval.

Earthworks

5. The consent holder shall ensure stormwater diversion and silt control measures are in place in accordance with the Erosion and Sediment Control Guide for Land Disturbing Activities in the Auckland Region (GD05) prior to the commencement of earthworks.

Photographic evidence of ESP measures being in place are to be emailed to FNDC Team Leader Monitoring and Compliance RCmonitoring@fndc.govt.nz referencing 2240061 – RMALUC.

6. The consent holder shall ensure that all earthwork operations are carried out in a way that reduces the risk of slope instability and soil erosion. To reduce and/or minimize any slope failures, effective mitigation measures must be constructed as needed.

During Construction / Physical Works

7. The construction activity shall be undertaken as per the approved Construction Management Plan referenced under Condition 1 of this consent and as per the Traffic Management Plan required under Condition 3 of this consent.
8. All construction works associated with the implementation of this resource consent shall only be carried out:
 - a. Monday to Friday – between the hours of 7:00am and 7:00pm
 - b. Saturday – between the hours of 7.30am and 6:00pm

No works shall be carried out on Sundays or public holidays.

9. For Sirens 62, 71 and 76, the monopole structure for the tsunami sirens shall be finished with a dark and recessive colour (<30% LRV).

Following construction, written confirmation from a suitably qualified Landscape Architect and/ or other evidence to demonstrate that the sirens achieved a low

reflectivity value of less than 30%, shall be provided to the approval of Council's RMA Compliance Officer (or delegated representative).

During Operation

10. The tsunami siren may be tested twice a year at the turn of daylight savings. Each test shall be undertaken for a maximum duration of two minutes during the daytime. Testing of the sirens shall not occur at night.

Advice note:

This condition relates solely to the testing of Tsunami Sirens. In the event of an actual or potential tsunami threat, the Siren can be activated at any time for any length of time necessary.

Advice Notes

Right of Objection

1. *If you are dissatisfied with the decision or any part of it, you have the right (pursuant to section 357A of the Act) to object to the decision. The objection must be in writing, stating reasons for the objection and must be received by Council within 15 working days of the receipt of this decision.*

Archaeological Sites

2. *Archaeological sites are protected pursuant to the Heritage New Zealand Pouhere Taonga Act 2014. It is an offence, pursuant to the Act, to modify, damage or destroy an archaeological site without an archaeological authority issued pursuant to that Act. Should any site be inadvertently uncovered, the procedure is that work should cease, with the Trust and local iwi consulted immediately. The New Zealand Police should also be consulted if the discovery includes koiwi (human remains). A copy of Heritage New Zealand's Archaeological Discovery Protocol (ADP) is attached for your information. This should be made available to all person(s) working on site.*

Reasons for the Decision

1. By way of an earlier report that is contained within the electronic file of this consent, it was determined that pursuant to sections 95A and 95B of the Act the proposed activity will not have, and is not likely to have, adverse effects on the environment that are more than minor, there are also no affected persons, and no special circumstances exist. Therefore, under delegated authority, it was determined that the application be processed without notification.
2. The application is for Discretionary and Non-Complying activity resource consents as such under section 104 the Council can consider all relevant matters. These matters are addressed below.
3. In regard to section 104(1)(a) of the Act the actual and potential effects of the proposal will be acceptable as:
 - a. Whilst the noise emitted from the sirens will exceed the thresholds for the relevant zones, the sirens will only sound on two occasions;
 - during bi-annual testing at the turn of daylight savings, in which testing will be undertaken during the day and for no more than two minutes. In this regard, whilst being “noisy”, this will be temporary and is necessary to ensure the function of the sirens as well as to ensure the wider public is familiar with the sound; and
 - during an emergency situation in which there is a threat to life and property, in which case the loud noise is a functional requirement of such a system in order to warn people of an emergency situation and the need to evacuate.
 - b. No sirens are to be located where they may affect known cultural and archaeological sites, and whilst they are located in and around the coast, as well as adjacent to Statutory Acknowledgement Areas, it is not anticipated that adverse effects on the values and significance of these areas will arise. Mana whenua have also not raised concerns with respect of the proposal.
 - c. A construction management plan and traffic management plan will ensure that the construction effects of installing the sirens is adequately managed.
 - d. The sirens are to be located next to, or in the immediate vicinity of existing infrastructure, such as public toilets, light and power poles and carpark areas, reducing any adverse effects on visual amenity of the area by ensuring all development is grouped together;
 - e. Where sirens are to be located in an outstanding landscape area, to ensure adverse effects on that visual amenity and character of the outstanding landscape, the monopoles of the sirens will be recessive in colour.
 - f. Whilst the sirens are all located in various natural hazard areas, it is not anticipated that the sirens will exacerbate the effect of the natural hazards.
 - g. The proposal will also result in positive effects in that it provides life saving infrastructure that provides advanced warning of an impending tsunami which poses a risk to property and life.
4. Overall, and on balance, accepting that there is a functional need for the sirens to be located in the localities they are proposed, due to there being residential development and being on the coast, as well as the functional need for the noise of the sirens to be as loud in order to warn of an emergency situation, it is considered that any adverse

effects are less than minor, and are outweighed by the positive effects and therefore are acceptable.

5. In regard to section 104(1)(ab) of the Act there are no offsetting or environmental compensation measures proposed or agreed to by the applicant for the activity, nor are any considered necessary.
6. In regard to section 104(1)(b) of the Act the following statutory documents are considered to be relevant to the application:
 - a. New Zealand Coastal Policy Statement 2011,
 - b. Northland Regional Policy Statement 2016,
 - c. Operative Far North District Plan 2009, and
 - d. Proposed Far North District Plan.

The activity is consistent with these documents for the reasons set out in Section 10 of the Assessment of Environmental Effects submitted with the application.

Operative Far North District Plan

The activity is consistent with the relevant objectives, policies, and assessment criteria of the Operative District Plan because:

Chapter 7 Urban Environment

Siren 91 is proposed to be located in the Residential Zone. The outcomes expected from this zone are Residential areas containing a range of activities that are compatible, in terms of their effects, with the predominant residential use and character of those areas.

Whilst the proposed siren is not specifically provided for in the urban environment or residential zone, the policies and objectives seek to enable other [non-residential] activities where the effects are compatible with the effects of the residential activity. It is considered that the effects of the proposed sirens are compatible with those of the residential zone, in that the proposed sirens in a residential zone are located in close proximity to existing infrastructure including light and power poles, within a formed road corridor and adjacent to public infrastructure such as public toilets. It is also aids in mitigating the effects of residential development in coastal environments being susceptible to tsunami hazards, by way of proving an emergency warning in the event of a tsunami where there is a risk to life and property. The sirens are well separated from residential sites therefore not adversely impacting on the access to sunlight and daylight on those sites and have no impact on the privacy of any inhabitants of those sites.

It is considered the proposal is consistent with the objectives and policies set out in Chapter 7.

Chapter 9 Recreation and Conservation Environment

Sirens 62, 71, 76, 87 and 89 are proposed to be located in the Recreation or Conservation Zone. The outcomes expected from this zone are recreation and conservation areas are managed and used consistent with the reasons for which they were set aside or reserved.

The objectives and policies of Chapter 9 seek to protect recreational and conservation purposes of the zone, preserving high conservation values by managing the effects of activities so as not to compromise the recreation and conservation values of the zone.

The proposed sirens are not specifically or directly provided for in these zones, in that they are not ancillary to conservation or recreation activities. However, they are not considered to compromise the purpose of the zone, or impact on conservation or recreation activities, or detract from any values associated with such activities. The sirens are also not anticipated to compromise recreation and conservation activities and values within their respective locations. There is no vegetation removal required, and land disturbance within the zone will be minor and temporary during construction.

It is considered that the proposal is not contrary to the objectives and policies of Chapter 9, in that it does not compromise conservation nor recreation activities within the zone, nor does it limit the ability for such activities to be undertaken.

Chapter 10 General Coastal Zone

Siren 70 is located in the General Coastal Zone. The zone is generally rural with coastal influence and natural character attributes. The zone, in summary, seeks to preserve the natural character of the coastal environment, consolidate development in existing settled areas, recognise and provide for Māori and their relationship with the coastal environment and development occurs in a manner compatible with the amenity values of the coastal environment.

The proposed siren will be consolidated with existing development and land disturbance of the coastal environment will be minor with no vegetation clearance. The applicant has consulted with mana whenua who have not raised any concerns regarding the proposal. The siren will not detract from the amenity values of the coastal environment and will not hinder or restrict public access to the coastal environment, nor will it hinder or restrict access by tangata whenua to sites of significance or takutai moana. There is a functional need to site the siren in the coastal environment within natural hazard areas, particularly tsunami hazard area, however it is not expected that the siren would exacerbate the effects of natural hazards, such as coastal erosion and flooding.

It is considered the proposal is consistent with the Chapter 10 policies and objectives.

Chapter 12 Natural and Physical Resources

Section 1 – Landscape and Natural Features

Sirens 70 and 71 are proposed to be located in areas mapped as outstanding landscapes. It is considered that the sirens will not detract from the outstanding landscape. The sirens will be consolidated with existing development, thus not increasing the visual dominance of development within outstanding landscapes, and do not result in an impenetrable view over the outstanding landscape from public viewpoints. In these areas, the monopoles will be recessive in colour, mitigating the visual effects to an acceptable level within outstanding landscape areas. No vegetation removal will occur and land disturbance within the area will be minimal, as such not degrading the outstanding landscape, nor resulting in the deterioration of the outstanding landscape values. There is a functional need for the sirens in these locations, and as such, it is not considered that such development would be inappropriate in these locations. The siren infrastructure is modest in size, ensuring

that the infrastructure does not dominate or compromise the characteristics, values, and attributes of these landscapes.

It is therefore considered that the proposal is consistent with the objectives and policies of the landscape and natural features section of Chapter 12

Section 4 - Natural Hazards

All sirens are proposed, by virtue of their function, are located within areas subject to natural hazards, including flooding coastal hazards and tsunami hazards. Although only Sirens 70, 71 and 91 are located in mapped hazard overlays. The outcomes expected from the natural hazard chapter are reduced risk to life, property and the environment from natural hazards, the appropriate control of development in natural hazard areas and Increased public awareness of the risks of natural hazards and the role of natural features in natural hazard mitigation.

The proposed sirens reduce the threat to life and property from natural hazards, namely tsunami's, through providing forewarning of an emergency allowing for the evacuation of at risk areas. The testing of the sirens provides for education and improved public awareness of the risk of tsunami and of the sirens as well as what to do in the event of a tsunami. The erection of the sirens will not exacerbate natural hazards and there is a functional need for them to be located where they are. The proposal does not detract from natural character or features, such as dunes and wetlands that naturally reduce/mitigate the effects of natural hazards, nor does it impede on their ability to do so or alter their function.

It is considered the proposal is consistent with the natural hazards section of Chapter 12 objectives and policies.

Conclusion of assessment of relevant policies and objectives of the ODP

Whilst the ODP does not directly or specifically provide for tsunami sirens, particularly in the various relevant zones they are proposed to be located in, the sirens do not detract from, or prevent from occurring or achieving, the intent of the provisions of the relevant zones. It is considered that whilst the proposal may not be wholly consistent with the policies and objectives of the ODP, it is not contrary to them either. It is also considered that the proposal does not prevent the plan intentions from being achieved, and the sirens will not be offensive to the character and amenity, or the intent of the zones in which they are proposed to be located in.

Proposed Far North District Plan

No resource consents have been triggered¹ under the PDP, as such only a high level assessment against the Plan is included. The activity is consistent with the relevant objectives and policies of the Proposed District Plan because:

The proposal results in tsunami siren infrastructure being located within the Rural Production, Natural open space, Rural Lifestyle, Sport and Active Recreation, Settlement, Open Space, General Residential, and Rural Residential Zones. The proposal also interreacts with overlays that include the Coastal Environment, High Natural Character Areas, Coastal Flood Zone 1, 2 and 3, Notable Tree, River Flood

¹ Earthworks are a permitted activity as outlined in the s95 report

Hazard 10- and 100-year ARI Event, Treaty Settlement Area of Interest, and Statutory Acknowledgement Area.

Again, whilst the PDP does not directly or specifically provide for tsunami sirens, particularly in the various relevant zones they are proposed to be located in, the sirens do not detract from, or prevent from occurring or achieving, the intent of the provisions of the relevant zones. It is considered that whilst the proposal may not be wholly consistent with the policies and objectives of the PDP, it is not contrary to them either. It is also considered that the proposal does not prevent the plan intentions from being achieved, and the sirens will not be offensive to the character and amenity, or the intent of the zones in which they are proposed to be located in.

Weighting of ODP v PDP

For this resource consent application, the relevant provisions of both an operative and any proposed plan must be considered. Weighting is relevant if different outcomes arise from assessments of objectives and policies under both the operative and proposed plans.

The PDP has only been recently notified and as such there is potential for change as the plan goes through the statutory process. As no resource consents are triggered under the PDP, and as with the ODP, the PDP does not specifically provide for tsunami sirens, little weight is given to the provisions of the PDP.

Regional Policy Statement for Northland

The Regional Policy Statement (RPS) for Northland contains high level policy guidance for development within the region and is the vehicle for identifying and dealing with significant resource management issues.

Of particular relevance to this proposal are:

- Objective 3.7 and 3.8 seek to provide for significant infrastructure that will protect health and safety of the community and recognise the importance of the long-term infrastructure.
- Objective 3.13 recognises the risk and impacts of natural hazard events. 3.13(b), (e) and (g) are of particular relevance to this proposal as they enable appropriate hazard mitigation measures to be constructed and recognise that critical infrastructure may have to be located within hazard prone areas.
- Policies 7.1.2 and 7.1.3 which seeks to manage new development in flood and coastal hazard areas.

Overall, as set described in the assessment against the ODP, it is considered there is a functional need for the sirens to be located where they are proposed to be, and that this does not detract from the values associated with those areas, nor does it create conflict with existing or anticipated activities. The sirens provide for the health and safety of the wider public, as well as reducing risks from natural hazards and increasing awareness of natural hazards, namely tsunamis. The sirens do not restrict the ability to achieve desired and intended regional outcomes, nor do they impact on public access to conservation land, recreation land or the coast. They are all outside of known cultural and historical sites.

It is considered that the proposal is not contrary to the policies and objectives of the RPS, nor the outcomes sought.

New Zealand Coastal Policy Statement 2011

The New Zealand Coastal Policy Statement (NZCPS), contains objectives and policies which include those aimed at safeguarding the integrity, form, functioning and resilience of the coastal environment and sustaining its ecosystems, and preserving the natural character of the coastal environment.

Of particular relevance to this proposal the following objectives and policies:

- Objective 2 and Policy 13 seek to preserve the natural character, features, and landscape values of the coastal environment.
- Objective 4 and Policies 18 and 19 seek to maintain and enhance public open space within the coastal environment by ensuring public access to the coast is retained and provided for.
- Objective 6 recognises that the protection of the values of the coastal environment does not preclude use and development in appropriate places and forms within appropriate limits, and that functionally some uses and development can only be located on the coast or in the marine area.
- Policy 6(2)(c) further acknowledges that there are activities with a functional need to be located in the coastal marine area.
- Policies 24 and 25 seek to identify areas that are potentially to be affected by coastal hazards such as tsunamis and how to avoid or mitigate them.

The proposed sirens have a functional need to be located within or near the coastal environment, of which such activities are acknowledged by the NZCPS. As has been detailed previously in this report and the notification report, it is not anticipated the proposal would give rise to minor or minor visual effects and landscape and character effects. Where the sirens are to be located in outstanding landscapes, the visual effects are mitigated through the use of recessive colours and being clustered together with existing infrastructure. The sirens are located in areas affected by tsunami hazards and provides lifesaving infrastructure to mitigate the risks of such hazards. The proposal does not restrict or hinder public access to the coastal marine area, or known sites of cultural or historical importance.

Overall, it is considered that the proposal is consistent with the policies and objectives of the NZCPS.

7. In conclusion, it is considered that the proposal is not contrary to the relevant statutory documents, nor does it restrict or hinder the intentions and outcomes sought by these documents from being achieved. The proposed sirens are not offensive to the locations in which they are proposed to be erected, nor the policy direction of the relevant statutory documents.
8. In regard to section 104(1)(c) of the Act, the following other matters are relevant and reasonably necessary to determine the application:

Northland Civil Defence Emergency Management Group Plan (EMGP) 2021-2026

The EMGP sets out the strategic direction of the Northland Civil Defence Emergency Management Group. The proposal is consistent with the objectives of the EMGP. One area of focus is to improve and maintain tsunami readiness and response and sets out actions which include ensuring that Northlands tsunami siren network meets the required national standards. The proposed replacements to the existing tsunami sirens will ensure that these standards are met.

Precedent Effects

With respect of Sirens 62, 71, 76, 87, 89 and 91, of which the application for resource consents is a non-complying activity, precedent effects are a relevant consideration.

The approval of the proposal will not undermine the integrity of the District Plan as the activity will produce only localised and minor effects, if any, and will not set an undesirable precedent, in that the provision of emergency warning systems has significant positive effects, that far outweigh the relatively minor (and in most cases) temporary adverse effects that arise from the sirens.

The proposal is considered to have unique features, in that it is for the provision of an emergency warning system, being a tsunami siren, that means despite the potential for other applications to be lodged, any precedent set will not result in the integrity of the plan being undermined. Furthermore, every resource consent application is assessed on a case by case basis.

9. In regard to section 104D of the Act and the application for Sirens 62, 71, 76, 87, 89 and 91, the proposal meets the “effects gateway”, as any adverse effects arising from this proposed activity will not be more than minor. Therefore, consent can be granted for this non-complying activity. For completeness, it is not considered that the proposal for sirens 62, 71, 76, 87, 89 and 91 would be contrary to the policies and objectives of the ODP. There is a functional need for the sirens to be located within the coastal or recreation activities zones, in spite of them not being ancillary to conservation or recreation activities, and to infringe the coastal marine area setback. There is also a functional need for Siren 91 to be located in a coastal hazard zone. These being the reasons for the non-complying activity status. The siting of siren 91 within the hazard area is not anticipated to exacerbate coastal hazards, nor increase their downstream effects on other property.
10. With respect to Siren 70, which is a Discretionary Activity, the adverse effects are anticipated to be less than minor, and the proposed sirens are not contrary to the policies and objectives of the relevant statutory documents.
11. Based on the assessment above the activity will be consistent with Part 2 of the Act.
The activity will avoid, remedy, and/or mitigate any potential adverse effects on the environment while providing for the sustainable management of natural and physical resources and is therefore in keeping with the Purpose and Principles of the Act.

With respect to the matters under section 6:

- the proposed sirens do not result in the deterioration or degradation of the coastal environment;

- the requirement for sirens in areas identified as outstanding landscape to be recessive in colour ensures adverse visual effects on outstanding landscapes are less than minor and acceptable;
- the sirens do not obstruct, hinder or prevent public access to the coastal marine area, nor do they alter public access and as such public access to such areas are maintained;
- the proposed sirens will have less than minor, if any, effects on known cultural and archaeological sites;
- the proposed sirens assist in the management of significant risks from natural hazards, specifically tsunami hazards, by providing an emergency warning of an impending tsunami, allowing those at risk can evacuate and providing forewarning of a tsunami making landfall.

With respect to section 8, the activity is not considered to raise any issues in regard to Te Tiriti o Waitangi.

12. Overall, for the reasons above it is appropriate for consent to be granted subject to the imposed conditions.

Approval

This report has been prepared by Alex Erceg - Stellar Projects, Senior Planner. I have reviewed this and the associated information (including the application and electronic file material) and for the reasons and subject to the conditions above, and under delegated authority, grant this resource consent.



Name: Pat Killalea

Date: 19th April 2024

Title: Independent Commissioner

**DECISION ON LAND USE CONSENT APPLICATION
UNDER THE RESOURCE MANAGEMENT ACT 1991**

Decision

Pursuant to section 34(1) and sections 104, 104B and 104D and Part 2 of the Resource Management Act 1991 (the Act), the Far North District Council **grants** land use resource consent for a Non-Complying activity, subject to the conditions listed below, to:

Applicant: Northland Regional Council

Council Reference: 2240382-RMALUC

Property Address:	Siren #	Address	Legal Description
	63	13 Church Street, Russell	Lot 2 DP 339185
	64	1/3 Baffin Street, Opuia	Lot 5 DP 367224
	65	Corner Te Haumi Drive and Paihia Road	Lot 224 DP 79931
	66	3 School Road, Paihia	Lot 5 DP 57340
	69	1009 Purerua Road, Te Tii	
	78	140 Waterfront Drive, Mangonui	Allot 294 TN OF Mangonui
	99	Road Reserve (Windsor Landing Boat Ramp and Jetty Carpark, Kerikeri Inlet Road	Parcel ID: 5206214
	100	Road Reserve (Waipapa Landing Jetty, Landing Road)	Parcel ID: 5225070
	101	117 State Highway 1, Awanui	Allotment 53 Parish of Awanui and Lot 1 DP 178617

The activities to which this decision relates are listed below:

To install and operate Tsunami Sirens at various locations across the Far North District.

Rule Number and Name	Non Compliance Aspect	Activity Status
Industrial Zone		
7.8.5.1.6 Noise	Siren will infringe the permitted noise threshold. #Siren 64	Restricted Discretionary Activity
Rural Living Zone		
8.7.5.1.3 Building Height	Building greater than 9m. Proposed height of 9.8m. Siren #100	Restricted Discretionary Activity
8.7.5.1.7 Screening for Neighbours – Non-Residential Activities	No landscaping is proposed. Siren #100	Restricted Discretionary Activity
8.7.5.1.11 Noise	Siren will infringe the permitted noise threshold. Siren #100	Restricted Discretionary Activity
12.7.6.1.1 Setback from Lakes, Rivers and the Coastal Marine Area	Siren will be approximately 17m from the CMA infringing the permitted setback of 30m by 13m. #Siren 100	Restricted Discretionary Activity
Recreational Activities		
9.6.5.1.1 Purpose of Buildings	The proposed siren is not directly for, or ancillary to, the principal recreational activities of the site and it cannot meet the RDA or DA standards. Sirens 66, 78 and 101.	Non-complying Activity
9.6.5.1.3 Building Height	Building greater than 8m. Proposed height of 9.1m. Sirens 66, 78 and 101.	Restricted Discretionary Activity
9.6.5.1.4 Sunlight	The siren cannot comply with the HIRB, and is setback 2.34m from the nearest boundary. Sirens 66, 78 and 101.	Restricted Discretionary Activity
9.6.5.1.6 Setback from Boundaries	Siren is 1.75m from the nearest boundary and cannot comply with the minimum setback of 2m. Siren #66	Restricted Discretionary Activity
9.6.5.1.9 Screening for Neighbours	No landscaping is proposed. Sirens 78 and 101.	Discretionary Activity.
9.6.5.1.12 Noise	Siren will infringe the permitted noise threshold. Sirens 66, 78 and 101.	Restricted Discretionary Activity
Conservation Zone		

9.7.5.1.1 Purpose of Buildings	The proposed siren is not directly for, or ancillary to, the principal conservation activities of the site in accordance with 9.7.5.1.1. Siren 65.	Non-complying activity
9.7.5.1.3 Building Height	Building greater than 8m. Proposed height of 9.123m. Siren 65.	Restricted Discretionary Activity
9.7.5.1.4 Sunlight	Siren is setback approximately 3m from the nearest boundary and therefore cannot comply. Siren 65.	Restricted Discretionary Activity
9.7.5.1.6 Screening from neighbours	No form of landscaping is proposed. Siren 65.	Discretionary activity.
9.7.5.1.8 Noise	Siren will infringe permitted noise threshold. Siren 65.	Restricted Discretionary Activity
General Coastal Zone		
10.6.5.1.4 Building Height	Building greater than 8m. Proposed height of 9.123m. Siren 69.	Discretionary Activity
10.6.5.1.10 Noise	Siren will infringe permitted noise threshold. Siren 69.	Restricted Discretionary Activity
Coastal Living Zone		
10.7.5.1.4 Building Height	Building greater than 8m. Proposed height of 9.1m. Siren 98.	Discretionary Activity
10.7.5.1.8 Screening for Neighbours Non-Residential Activities	No form of landscaping is proposed. Siren 98.	Discretionary Activity
10.7.1.12 Noise	Siren will infringe the permitted noise threshold. Siren 98.	Restricted Discretionary Activity
12.7.6.1.1 Setback from Lakes, Rivers and the Coastal Marine Area	The siren will be approximately 14m from the CMA, infringing the permitted setback of 30m by 16m. Siren 98.	Discretionary Activity
Russell Township Zone		
10.9.5.1.4 Building Height	Siren is proposed to be 9.1m high breaching the permitted height of 7.2m. Siren 63.	Discretionary Activity
10.9.5.1.6 Sunlight	Siren cannot comply with the HIRB and is setback 2.34m from the nearest boundary. Siren 63.	Restricted Discretionary Activity
10.9.5.1.13 Noise	Siren will infringe the permitted noise threshold. Siren 63.	Restricted Discretionary Activity

Conditions

Pursuant to sections 108 of the Act, this consent is granted subject to the following conditions:

1. The activity shall be carried out in general accordance with the approved plans to this consent with the Councils "Approved Stamp" affixed to them.

Author	Project	Sheet/Drawing	Rev.	Dated
Tutukaka Consultants Limited	Northland Tsunami Siren Network	231203/03	A	07/23
Tutukaka Consultants Limited	Northland Tsunami Siren Network	231203/17	A	07/23
Tutukaka Consultants Limited	Northland Tsunami Siren Network	231203/05	A	07/23
Tutukaka Consultants Limited	Northland Tsunami Siren Network	231203/07	A	07/23
Tutukaka Consultants Limited	Northland Tsunami Siren Network	231203/18	A	07/23
Tutukaka Consultants Limited	Northland Tsunami Siren Network	231203/22	A	07/23
Tutukaka Consultants Limited	Northland Tsunami Siren Network	231206/13	A	07/23
Tutukaka Consultants Limited	Northland Tsunami Siren Network	231203/14	A	07/23
Tutukaka Consultants Limited	Northland Tsunami Siren Network	231203/36	A	07/23

Earthworks

2. The consent holder shall ensure stormwater diversion and slit control measures are in place in accordance with the Erosion and Sediment Control Guide for Land Disturbing Activities in the Auckland Region (GD05) prior to the commencement of earthworks. Photographic evidence of ESP measures being in place are to be emailed to FNDC Team Leader Monitoring and Compliance at RCmonitoring@fndc.govt.nz referencing 2240382-RMALUC.

3. The consent holder shall ensure that all earthwork operations are carried out in a way that reduces the risk of slope instability and soil erosion. To reduce and/or minimize any slope failures, effective mitigation measures must be constructed as needed.

During Construction / Physical Works

4. All construction works associated with the implementation of this resource consent shall only be carried out:
 - a. Monday to Friday – between the hours of 7:00am and 7:00pm
 - b. Saturday - between the hours of 7:30am and 6:00pm

No works shall be carried out on Sundays or public holidays.

5. The installation of the footings for the Tsunami Warning Sirens are to be checked and certified by a suitably qualified engineer with consideration given to its site-specific soil conditions (good ground) and its potential exposure to erosion/inundation where they are located within a NRC natural hazard zone.

This applies specifically to the sites in river flood prone areas (sites 63, 64, 66 and 101) and for sites within a coastal flood zone (site 63, 64, 66, 99 and 100).

During Operation

6. The tsunami sirens may be tested twice a year at the turn of daylight savings. Each test shall be undertaken for a maximum duration of two minutes during the daytime. Testing of the sirens shall not occur at night.

Advice note. This condition relates solely to the testing of Tsunami Sirens. In the event of an actual or potential tsunami threat, the siren can be activated at any time for any length of time necessary.

Advice Notes

Lapsing of Consent

1. Pursuant to section 125 of the Act, this resource consent will lapse 5 years after the date of commencement of consent unless, before the consent lapses;
 - a) The consent is given effect to; or
 - b) An application is made to the Council to extend the period of consent, and the council decides to grant an extension after taking into account the statutory considerations, set out in section 125(1)(b) of the Act.

Right of Objection

2. If you are dissatisfied with the decision or any part of it, you have the right (pursuant to section 357A of the Act) to object to the decision. The objection must be in writing, stating reasons for the objection and must be received by Council within 15 working days of the receipt of this decision.

Archaeological Sites

3. Archaeological sites are protected pursuant to the Heritage New Zealand Pouhere Taonga Act 2014. It is an offence, pursuant to the Act, to modify, damage or destroy an archaeological site without an archaeological authority issued pursuant to that Act. Should

any site be inadvertently uncovered, the procedure is that work should cease, with the Trust and local iwi consulted immediately. The New Zealand Police should also be consulted if the discovery includes koiwi (human remains). A copy of Heritage New Zealand's Archaeological Discovery Protocol (ADP) is attached for your information. This should be made available to all person(s) working on site.

Reasons for the Decision

1. By way of an earlier report that is contained within the electronic file of this consent, it was determined that pursuant to sections 95A and 95B of the Act the proposed activity will not have, and is not likely to have, adverse effects on the environment that are more than minor, there are also no affected persons and no special circumstances exist. Therefore, under delegated authority, it was determined that the application be processed without notification.
2. The application is for a Discretionary and Non-Complying activity resource consent as such under section 104 the Council can consider all relevant matters.
3. In regard to section 104(1)(a) of the Act the actual and potential effects of the proposal will be acceptable as:
 - a. Whilst the noise emitted from the sirens will exceed the thresholds for the relevant zones, the sirens will only sound on two occasions;
 - During bi-annual testing at the turn of daylight savings, in which testing will be undertaken during the day and for no more than two minutes. In this regard, whilst being 'noisy' this will be a temporary and is necessary to ensure the function of the sirens as well to ensure the wider public is familiar with the sound; and
 - During an emergency situation in which there is a threat to life and property, in which case the loud noise is a functional requirement of such a system in order to warn people of any emergency situation and the need to evacuate.
 - b. Access and traffic effects are less than minor as construction works will be short in duration and the safe operation of the roading network will be maintained during the works.
4. In regard to section 104(1)(ab) of the Act there are no offsetting or environmental compensation measures proposed or agreed to by the applicant for the activity.
5. In regard to section 104(1)(b) of the Act the following statutory documents are considered to be relevant to the application:
 - a. New Zealand Coastal Policy Statement 2011,
 - b. Northland Regional Policy Statement 2016,
 - c. Operative Far North District Plan 2009,
 - d. Proposed Far North District Plan 2022

New Zealand Coastal Policy Statement 2011

The New Zealand Coastal Policy Statement (NZCPS) sets out objectives and policies in order to achieve the purpose of the RMA in regards to the coastal environment of New Zealand. It is noted that the installation and construction of the 9 tsunami sirens around

the Far North District have a functional and operational need to be located within the coastal environment of which such activities are acknowledged by the NZPS. Of particular relevance to this application are the following objectives and policies:

- *Objective 2 and policy 13 which seek to preserve the natural character, features and landscape values of the coastal environment.*
- *Objective 4 and policies 18 and 19 seek to maintain and enhance public open space within the coastal environment by ensuring public access to the coast is retained and provided for.*
- *Objective 6 recognises that the protection of the values of the coastal environment does not preclude use and development in appropriate places and forms within appropriate limits, and that functionally some uses and development can only be located on the coast or in the marine area.*
- *Policy 692)(c) further acknowledges that there are activities with a functional need to be located in the coastal marine area.*
- *Policies 24 and 25 seek to identify areas that are potentially to be affected by coastal hazards such as tsunamis and how to avoid or mitigate them.*

As detailed in the notification report, the activity will not result in any adverse effects with regards to visual amenity, landscaping and character effects. Whilst all structures exceed the height limits with the coastal environment, when taking into account their dimensions of the sirens which are the largest component of the infrastructure, the effects on the wider environment are considered to be relatively modest. They will be visible but consistent with the overall built form of the wider environment. The sirens do not restrict public access in any way and the sirens are predominantly not identified as an outstanding feature or landscape. On this basis, it is considered that the activity is consistent with the objectives and policies of the NZCPS.

Northland Regional Policy Statement

With respect to the coastal environment, the Northland Regional Policy Statement (NRPS) contains objectives and policies which seek to protect and preserve the natural character of the coastal environment. Of particular relevance to this proposal are as follows:

- *Objective 3.7 and 3.8 seek to provide for significant infrastructure that will protect health and safety of the community and recognise the importance of the long-term infrastructure.*
- *Objective 3.13 recognises the risk and impacts of natural hazard events. 3.13(b), (e) and (g) are of particular relevance to this proposal as they enable appropriate hazard mitigation measures to be constructed and recognise that critical infrastructure that may have to be located within hazard prone areas.*
- *Policy 4.8 recognises that structures that have a functional need can be located within the coastal marine area and structures that will make a significant positive contribution to the local area of region.*

Naturally, to maximise the purpose of the sirens, these are located strategically across the district in order for the alert to reach the most people possible. The proposed sirens

are considered lifesaving infrastructure, designed to improve community resilience, readiness and response to the threat of tsunami risk. The sirens are relatively modest structures and are considered to be structurally resilient. On this basis, it is considered the sirens are consistent with the objectives and policies of the Northland RPS.

Far North District Operative District Plan (ODP)

Russell Township Zone

Objective: 10.9.3.1

Policies: 10.9.4.1, 10.9.4.7

Siren 63 will be viewed in the context of the wider of the low density residential area. Further the siren will provide for a functional and operational need to alert communities within the Russell Township of potential tsunami threat and hazards. The structure is relatively modest in terms of footprint and mass, are non-habitable and only involve minimal earthworks to establish the building platform. Consequently, the siren can achieve objective 10.9.3.1 and preserve the character of Russell Township (Policy 10.9.4.7). The notification report deemed effects of the installation and construction of the siren to be less than minor and of small scale, and as such is considered consistent with the existing development (Policy 10.9.4.1).

Industrial Zone

The Industrial zone includes the existing areas of industrial activity in the District and provides for the expansion of industry in these areas. By identifying a sperate Industrial Zone, the Council is indicating that the effects of industrial activities are able to be managed most effectively if the activities that give rise to the effects are grouped together.

The proposed siren 64 infrastructure complies with all bulk and location controls of this zone with the exception of noise. The noise emissions generated by the sirens during an emergency event are considered lifesaving infrastructure, designed to improve community resilience, readiness and response to the threat of tsunami risk. On this basis, it is considered the siren is consistent with the objectives and policies of the Industrial Zone.

Conservation Zone

Objectives: 9.7.3.2, 9.7.3.3

Policies: 9.7.4.1, 9.7.4.2

Siren 65, as noted above has an important functional and operational need. The installation is a very small scale activity and will not have any adverse effects on the existing conservation area and will continue to be maintained and enhanced (Objective 9.7.3.2 and 9.7.3.3 and Policy 9.7.4.1). The siren will be constructed within an existing clearing at the edge of the vegetation and is clustered with existing FNDC infrastructure. The infrastructure will not result in domination, loss of privacy or overshadowing on neighbouring lots (Policy 9.7.4.2). Siren 65 is considered consistent in achieving the objectives and policies of the Conservation Zone.

Recreational Activities Zone

Objective: 9.6.3.2

Policies: 9.6.4.1

Sirens 65 and 101 are located within the Recreational Activities Zone. The siren infrastructure is small in scale and any effects are considered to be less than minor and compatible with the surrounding environment (Objective 9.6.3.2). The siren will be viewed in context with the wider environment and will be similar to other street infrastructure such as light poles. While the infrastructure is not directly provided for, thus, not directly ancillary to the purpose of the zone, the sirens are not considered to compromise the purpose of the zone and more specifically the areas of location (Policy 9.6.4.1). The sirens are considered to achieve the objectives and policies of the Recreational Activities zone.

General Coastal Zone and Coastal Living Zone

Siren 69 is proposed within the General Coastal Zone and sirens 98 and 99 are proposed within the Coastal Living Zone. The proposed siren infrastructure is considered to be relatively modest in scale and sized. The installation involves minor land disturbance that will be appropriately managed and temporary. With regards to landscape and visual amenity, the sirens are considered to be acceptable in this location, as the infrastructure will be clustered with existing public facilities so as to contain the visual impacts of the activity within an already modified environment.

Overall, the siren infrastructure is considered to be consistent with intent of the two zones.

Rural Living Zone

The objectives and policies of the zone seek to provide for a wide range of activities, while managing the effects of activities that are incompatible with the rural living zone. The proposed siren infrastructure is not considered to be incompatible, as it does not restrict existing activities or generate reverse sensitivity effects that may limit the purpose of the zone.

It is therefore, considered to be consistent with the objectives and policies of this zone.

Proposed District Plan

The activity is consistent with the objectives and policies of the Proposed District Plan. Notably, Siren 63 and 66 trigger reasons for consent under the PDP within Kororareka Russell Township and Open Space. Similarly as the ODP, the activity will remain consistent with the objectives and policies of the two zones.

For this resource consent application the relevant provisions of both an operative and any proposed plan must be considered. Weighting is relevant if different outcomes arise from assessments of objectives and policies under both the operative and proposed plans.

As the outcomes sought are the same under the operative and the proposed plan frameworks, no weighting is necessary.

6. In regard to section 104(1)(c) of the Act there are no other matters relevant and reasonably necessary to determine the application:

Northland Civil Defence Emergency Management Group Plan (EMGP) 2021-2026

The EMGP sets out the strategic direction of the Northland Civil Defence Emergency Management Group. The proposal is consistent with the objectives of the EMGP. One area of focus is to improve and maintain tsunami readiness and response and sets out actions which include ensuring that Northlands tsunami siren network meets the required national standards. The proposed replacements to the existing tsunami sirens will ensure that these standards are met.

Precedent Effects

The approval of the proposal will not undermine the integrity of the District Plan as the activity will produce only localised and minor effects, if any, and will not set an undesirable precedent, in that the provision of emergency warning systems has significant positive effects, that far outweigh the relatively minor (and in most cases) temporary adverse effects that arise from the sirens.

The proposal is considered to have unique features, in that it is for the provision of an emergency warning system, being a tsunami siren, that means despite the potential for other applications to be lodged, any precedent set will not result in the integrity of the plan being undermined. Furthermore, every resource consent application is assessed on a case by case basis.

7. In regard to section 104D of the Act the activity meets both tests as any adverse effects arising from this proposed activity will not be more than minor, and the activity will not be contrary to the objectives and policies of the Operative District Plan. Therefore, consent can be granted for this non-complying activity.
8. Based on the assessment above the activity will be consistent with Part 2 of the Act.

The activity will avoid, remedy or mitigate any potential adverse effects on the environment while providing for the sustainable management of natural and physical resources and is therefore in keeping with the Purpose and Principles of the Act. There are no matters under section 6 that are relevant to the application. The proposal is an efficient use and development of the site that will maintain existing amenity values without compromising the quality of the environment. The activity is not considered to raise any issues in regard to Te Tiriti o Waitangi.
9. Overall, for the reasons above it is appropriate for consent to be granted subject to the imposed conditions.

Approval

This resource consent has been prepared by Salamasina Brown, Intermediate Planner. I have reviewed this and the associated information (including the application and electronic file material) and for the reasons and subject to the conditions above, and under delegated authority, grant this resource consent.

P. G. Killalea

Name: Pat Killalea

Date: 10th May 2024

Title: Independent Commissioner

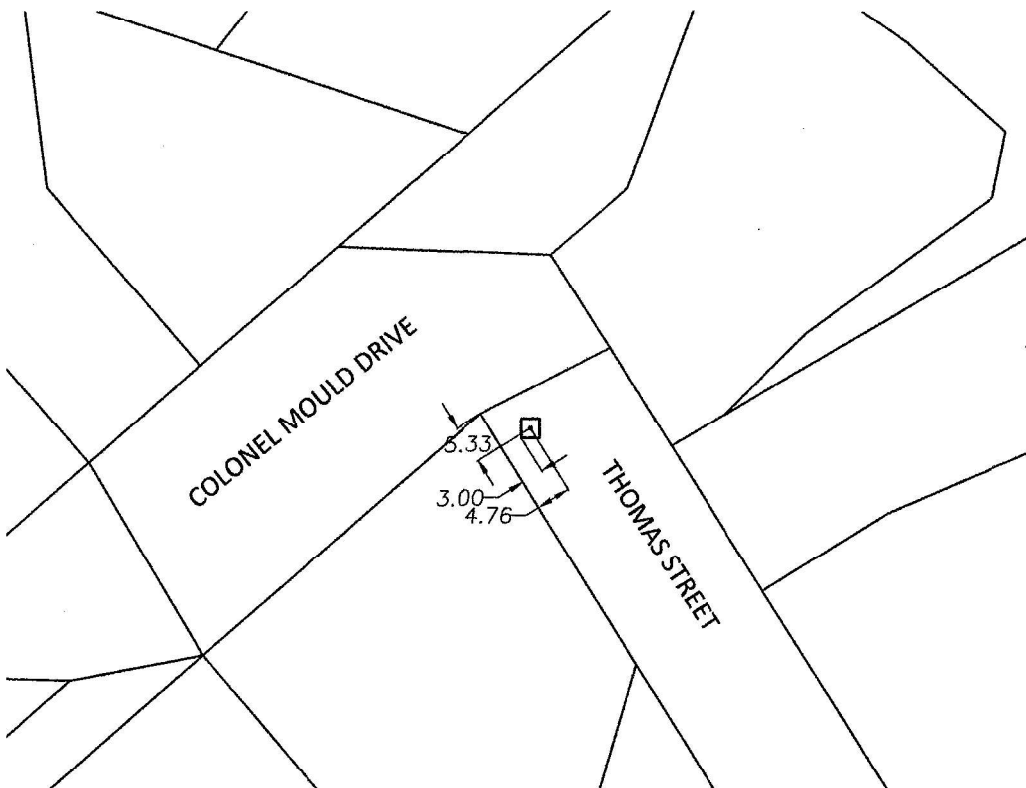
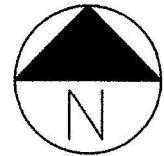

NOTE:

FOUNDATION PAD PLAN SIZE 2.5m BY 2.5m

OVERALL HEIGHTS:

TWS-293 SIREN MODULE 9.123m

TWS-295 SIREN MODULE 9.758m

**SITE NO 78- SIREN TYPE TWS-295
 THOMAS ST, BETWEEN 5 AND 9 COLONEL MOULD DRIVE
 GEOLOCATION -34.98977N, 173.534996E**

TUTUKAKA CONSULTANTS LIMITED Consulting Engineers 50 Taonga Lane, Tutukaka Whangarei 0173 Phone (09) 434 3694, 0221 880 870 E-mail: wayne@tutukakaco.com	client: NORTHLAND REGIONAL COUNCIL	location: FAR NORTH DISTRICT
	project: NORTHLAND TSUNAMI SIREN NETWORK	drawing title: RESOURCE CONSENT STAGE 1 - SEPARABLE PORTION 1
Northland REGIONAL COUNCIL Te Kaunihera ā rohe o Te Taitokerau	SCALES: 1:2000	REVISIONS A ISSUE FOR CLIENT APPROVAL
	FILE: SIREN LOC NORTH01 DATE: 07/23 ORIGINAL SIZE: A4	DRAWING NUMBER 231203/22



Tsunami Siren # 78
Siren Type: 295

Location: Thomas Street,
between 5 and 9 Colonel
Mould Drive

GPS: -34.98997, 173.534996

Property Owner: Far North
District Council

Parcel ID: 5239027

Legal Desc: Road Reserve

Record of Title:

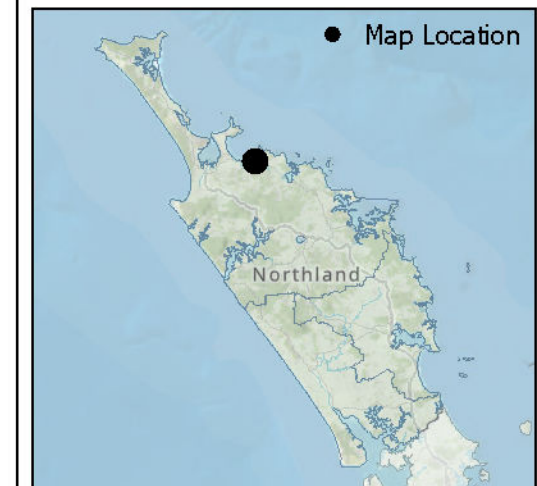

Data sources: Eagle Technology, Land Information New Zealand and
Northland Regional Council

Tsunami Siren # 78 - Mangonui

A3 Scale: 1:1,000

0 12.5 25 50 m



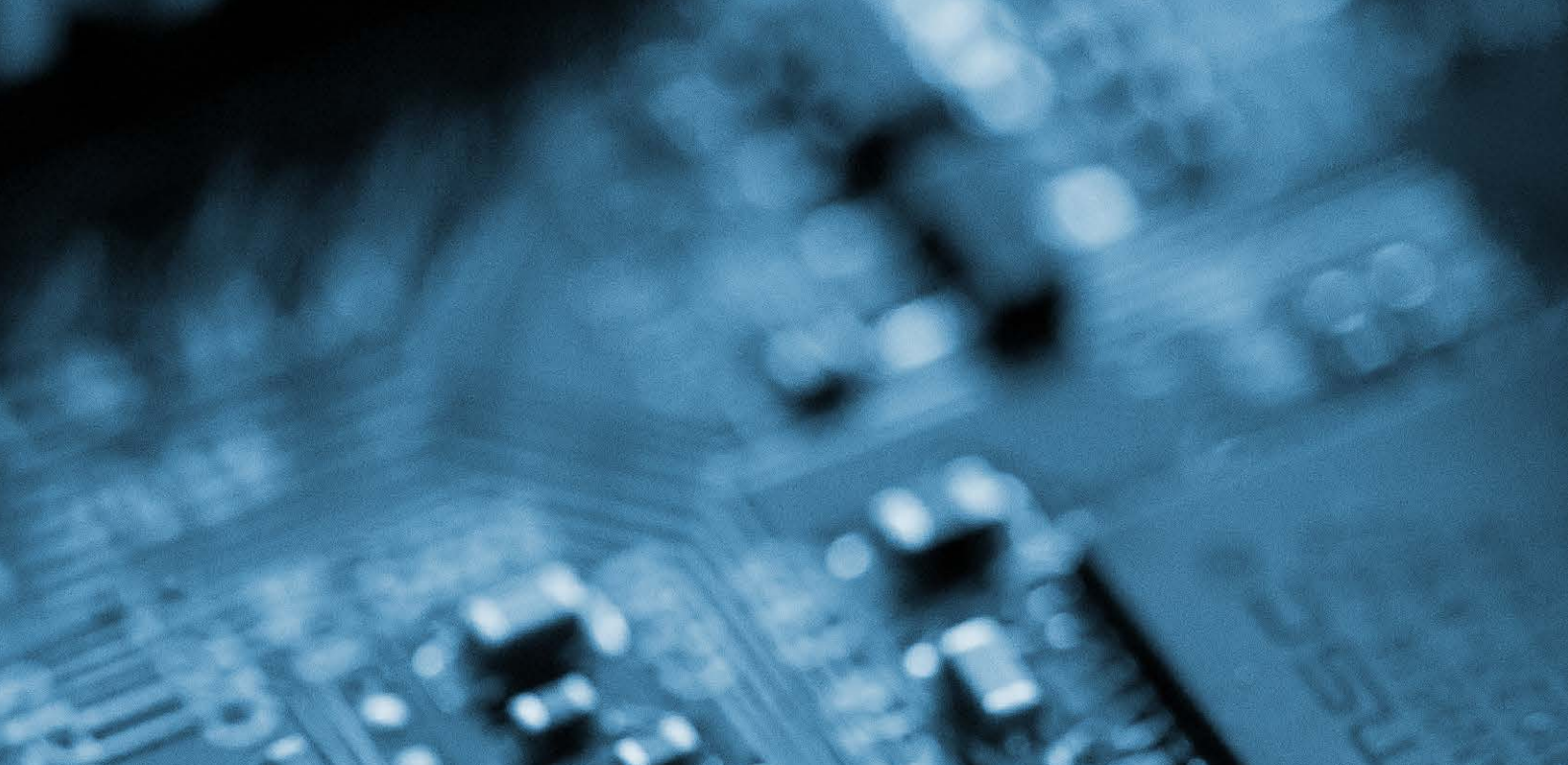

Project:
Northland Regional Council
May 31, 2021

DATASHEETS

HSS



ENGINEERING®
WARNING SYSTEM SOLUTIONS





Gabinete electrónico de dos compartimentos

HSS

ENGINEERING®
WARNING SYSTEM SOLUTIONS

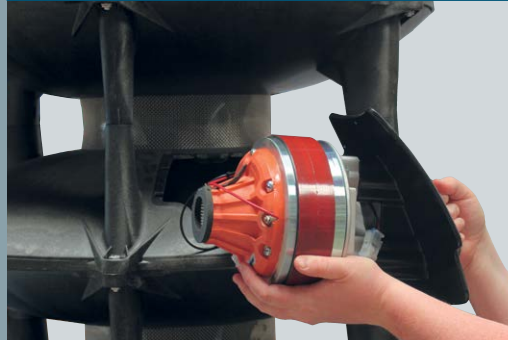

Las sirenas de la serie TWS-290 son las más confiables en el mercado para tonos de alerta y comunicación por voz

SIRENAS ELECTRÓNICA DE ALTO POTENCIA

TWS-295

La combinación de potentes tonos de alarma de alta eficiencia y una transmisión de voz clara e inteligible garantiza una excelente advertencia durante cualquier emergencia. Esto permite al operador notificar y dirigir una advertencia a la población afectada. Con un diseño superior del grupo de altavoces TWS proporciona una verdadera salida de sonido de 360° en todo el rango de frecuencias. La serie TWS-290, con sus amplificadores de alta eficiencia y Los controladores de altavoz duraderos EZ-PULL™ pueden proporcionar advertencia continua durante un mínimo de 30 minutos a plena potencia de salida, únicamente con la energía de la batería. Todos los componentes electrónicos están integrados en un gabinete de aluminio resistente a la corrosión de alta calidad.

CARACTERÍSTICAS

- 5 Módulos omnidireccionales de altavoces ensamblados en una columna vertical
- Gabinete de aluminio con clasificación IP66 con compartimiento de batería separado
- SPL 123 dB(C) @ 100' / 30 m
- El altavoz TWS-295 incluye 5 speakers drivers EZ-PULL™ de alta eficiencia
- Amplificador y transductores de sonido de calidad superior
- Cable de altavoz de 15 metros incluido
- Alimentado por batería, un mínimo de 30 minutos de potencia total con baterías de nuestra recomendación
- Cargador baterías, conmutación por 3 etapas compensada por temperatura
- Controles locales o controles remotos
- 5 Amplificadores de potencia de alta eficiencia
- Controlador de sirena electrónico con SI TEST® - Autocomprobación / diagnóstico silencioso
- Generador de tonos de alarma, transmisión de voz automática y en vivo
- Monitoreo de estado completo que incluye alarma de batería baja, estado del amplificador / altavoz
- Pararrayos de CA incluido (pararrayos de antena incluido con opción TWS-RADIO)
- Seis tonos de advertencia estándar – Wail, Whoop, Attack, Hi-Lo, Alert, Airhorn
- Tonos de advertencia personalizados opcionales
- Tipo de amplificadores Clase D
- Fabricado en polímero de carbono reforzado con fibra no corrosivo. Material no metálico
- Índice de inteligibilidad de STI 0,99. Capacidad de voz clara con respuesta de frecuencia de alta calidad



RENDIMIENTO ACÚSTICO

SPL @ 1 metro:	153 dB(C)
SPL @ 30 metros:	123 dB(C)
70dB rango ISO 13475-1*:	14,320 m
70dB rango estándar FEMA**:	1,280 m

* ISO: Reducción de la presión acústica de 6 dB pr. duplicación de la distancia (según ISO 13475-1)

** FEMA: Reducción de presión sonora de 10 dB pr. duplicación de la distancia (según las pautas de FEMA)

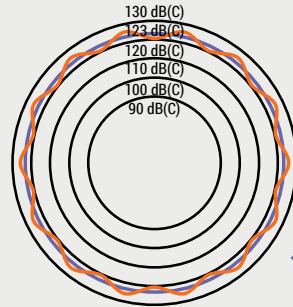

CONDICIONES DEL ENTORNO

Temperatura de operación	-35° C a + 70° C
Temperatura de almacenamiento	-65° C a + 125° C
Humedad no condensada	0 to 95 %

El diseño superior del grupo de altavoces proporciona una verdadera salida de sonido de 360° en todo el rango de frecuencias. SPL +/- 1 dB de disminución en 360°

ELECTRÓNICA DEL SISTEMA

Alimentación de entrada a cargador de batería	120/240 VCA o 50/60 Hz
Salida de cargador de batería	28 VDC, 10A #
Baterías	2 unidades, cada una con 12 V, AGM sellada. 100 AH. consumo en funcionamiento
Consumo en Standby	82 mA, 24 VDC
Corriente de Funcionamiento	111 A, 24 VDC
Potencia de salida por transductor	(típica / máxima) 400 Watts / 600 Watts
Potencia de salida total	(típica / máxima) 2000 Watts / 3000 Watts

U.L. Componente Reconocido

Componentes	Altura cm (pulgadas)	Ancho cm (pulgadas)	Fondo cm (pulgadas)	Peso kg(lbs)
TWS-295 Speaker	178,8 (70,4)	84,8 (33,4)		137,5 (303)
Gabinete Electrónico	84,5 (33,3)	58,0 (22,8)	35,0 (13,8)	43,0 (94,9)*

* Menos baterías. Dos baterías: 12 V, selladas. Calcio - Plomo, 24 kg adicionales por batería. No kit de radio. Si se selecciona esta opción adicionar 2,5 kg.

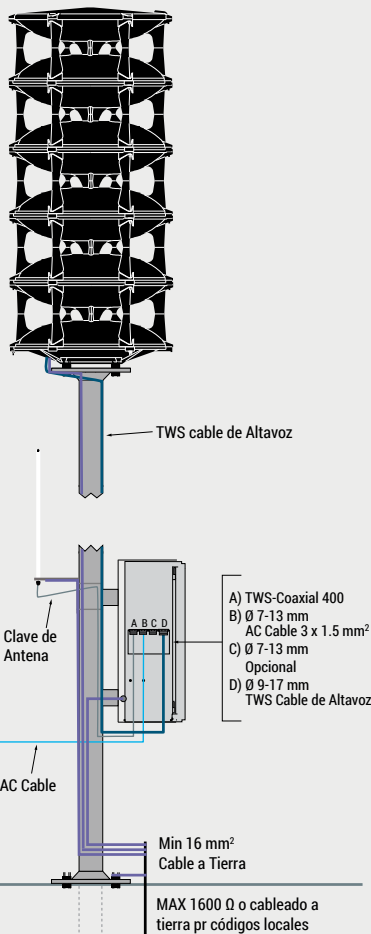

INFORMACIÓN PARA LA ORDEN

Descripción del producto	Orden No.
Conjunto de altavoces y gabinete de electrónica	TWS-295
Opciones	
Placa de control de estado / activación auxiliar para contacto Activación y estado de cierre	AUXCS
Placa de activación auxiliar para cierre de contacto	AUXIN
Unidad de fuente de alimentación directa de AC de alta eficiencia	TWS -AC-PCU
Módulo GSM	GV-GSM-RTU
Ethernet control / status interface	GV-IP
Control de estado / control de línea bidireccional de Giant Voice®	GV-LLM
Radios con opciones analógicas o digitales con amplio rango de frecuencia dentro de VHF y UHF	TWS-RADIO
Alerta visual omnidireccional	TWS-VISUALERT
Luz estroboscópica montada en celda superior	TWS-TL31R
Interfaz de Giant Voice® a interfaz Whelen	GV-PGINT
Tonos con Sistema PAGA existente	
Alarma de Intrusión	TWS INTRU
Alimentación fotovoltaica/Solar	TWS-SBC200
Par de baterías (2 pcs)	TWSBATT
Escudo Solar para Gabinete Electrónico	TWS SUN SHIELD
Tonos de alerta personalizados	GV-TONES

REV. C

HSS



ENGINEERING®
WARNING SYSTEM SOLUTIONS

HSS Engineering A/S
Laegaardsvej 12 · 8520 Lystrup · Denmark
Phone + 45 7022 8844
www.hss.dk · info@hss.dk



Two compartment electronics cabinet

HSS

ENGINEERING®
WARNING SYSTEM SOLUTIONS



The TWS-290 siren series is the most reliable warning siren system on the market for both warning tones and voice communication

ALL HAZARD HIGH-POWER SIREN SYSTEM TWS-293

The combination of powerful high efficiency alarm tones and clear, intelligible voice broadcast ensures an excellent warning during any emergency. This enables the operator to notify and direct a warning to the affected population. The superior design of the TWS speaker cluster provides a true 360° sound output throughout the entire frequency range. The TWS-290 series, with its high-efficiency amplifiers and durable EZ-PULL™ speaker drivers, can provide continuous warning for a minimum of 30 minutes at full output power, solely from battery power. All electronics are built into a high-quality corrosion resistant aluminum cabinet.

This makes the TWS-290 siren series the preferred Mass Notification Solution by our customers worldwide.

FEATURES

- 3 omni-directional speaker cells assembled in a vertical column
- IP 66 rated aluminum cabinet with separate battery compartment
- 119 dB(C) @ 100' / 30 m
- TWS-293 speaker includes 3 pcs high efficiency EZ-PULL™ speaker drivers
- 600 Watts per speaker driver rated max. output power for superior durability
- 15 m speaker cable included
- Battery powered, minimum of 30 minutes of full power output with batteries of our recommendation
- Temperature compensated 3-stage switch mode battery charger
- Local or remote control / status
- 3 pcs high efficiency power amplifiers
- Electronic siren controller featuring SI TEST® - Silent self-test / diagnostics
- Alarm tone generator, automatic and live voice broadcast
- Full status monitoring including low battery alarm, amplifier / speaker status
- AC lightning arrestor included (antenna lightning arrestor included with TWS-RADIO option)
- Six standard warning tones – Wail, Whoop, Attack, Hi-Lo, Alert, Airhorn
- Optional customized warning tones



ACOUSTIC PERFORMANCE

SPL @ 1 m:	149 dB(C)
SPL @ 30 m:	119 dB(C)
70dB range ISO 13475-1*:	9,110 m
70dB range FEMA standard**:	914 m

* ISO: 6 dB sound pressure reduction pr. doubling of distance (as per ISO 13475-1)

** FEMA: 10 dB sound pressure reduction pr. doubling of distance (as per FEMA guidelines)

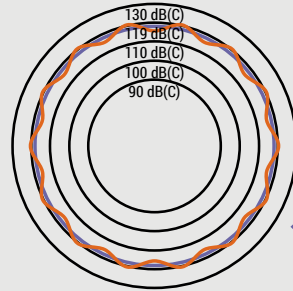

ENVIRONMENTAL

Operating temperature	-35° C to +70° C
Storage temperature	-65° C to +125° C
Humidity, non-condensing	0 to 95 %

The superior design of the speaker cluster provides a true 360° high sound output throughout the entire frequency range.

ELECTRICAL

Battery charger input	Option of 120/240 VAC or 50/60 Hz
Battery charger output	28 VDC, 10A*
Batteries	2 pcs 12 V, AGM sealed. 100 AH. Sold separately
Standby current	82 mA, 24 VDC
Operating current	23 A, 24 VDC
Normal amplifier output power	400 Watts during tone / 500 Watts during voice
Rated total max. output power	1800 Watts

U.L. recognized component

Component	Height cm (inches)	Width cm (inches)	Depth cm (inches)	Weight kg (lbs.)
TWS-293 speaker	115.3 (45.4)	84.8 (33.4)		93 (205)
Electronics cabinet	84.5 (33.3)	58.0 (22.8)	35.0 (13.8)	36.4 (80.1)*

* Less batteries. Two batteries: 12 V, sealed, lead-calcium, add 24 kg pr. battery. Less optional radio kit. Add 2.5 kg, if this option is selected.

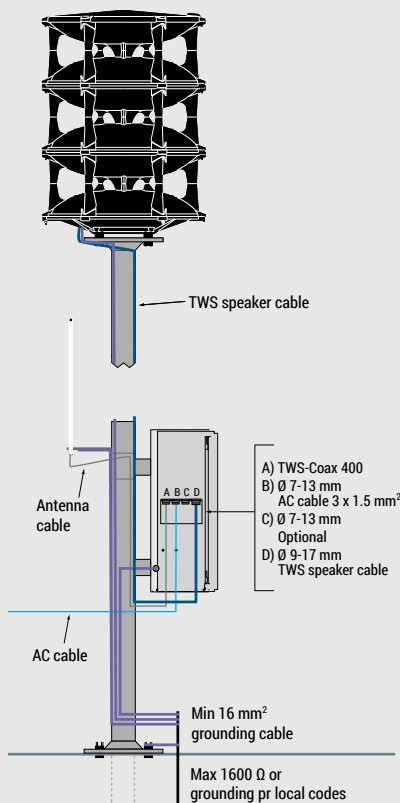

ORDERING INFORMATION

Product Description	Order No.
Speaker assembly and electronics cabinet	TWS-293
Options	
Auxiliary activation / status control board for contact closure activation and status	AUXCS
Auxiliary activation board for contact closure	AUXIN
High efficient AC direct power supply unit	TWS-AC-PSU
GSM module	GV-GSM-RTU
Ethernet control / status interface	GV-IP
Giant Voice® Two way landline control / status monitoring	GV-LLM
High standard radios in both analogue and digital versions with wide frequency range within both VHF and UHF	TWS-RADIO
Omni-directional visual lighting	TWS-VISUALERT
Top mounted strobe light	TWS-TL31R
Giant Voice® Paging interface to interface TWS warning with existing paging systems	GV-PGINT
Intrusion alarm	TWS-INTRU
Solar power	TWS-SBC100
Two pairs of batteries	TWSBATT
Sun shield for electronic cabinet	TWS SUN SHIELD
Customized warning tones	GV-TONES

REV. H

HSS



ENGINEERING®
WARNING SYSTEM SOLUTIONS

HSS Engineering A/S
Laegaardsvej 12 · 8520 Lystrup · Denmark
Phone + 45 7022 8844
www.hss.dk · info@hss.dk

Three things you
need to know in
order to save lives

ALERT INFORM DIRECT



HSS



ENGINEERING[®]
WARNING SYSTEM SOLUTIONS

Standard tones

IT'S IMPORTANT THAT THE PRODUCT YOU CHOOSE SOUNDS RIGHT

Comes with six standard warning tones

Tone	Tone symbol	Frequency	Period of time
Wail	~~~~~	410-675 Hz	4 sec / 1 sec
Alert	▬	560 Hz	Steady
Hi/Lo	465/650 Hz	8 sec / 8 sec
Attack	~~~~~	410-490 Hz	1 sec / 1 sec
Air Horn	465-650 Hz	Modulated / 1.6 sec
Whoop	//////	300-465 Hz	3

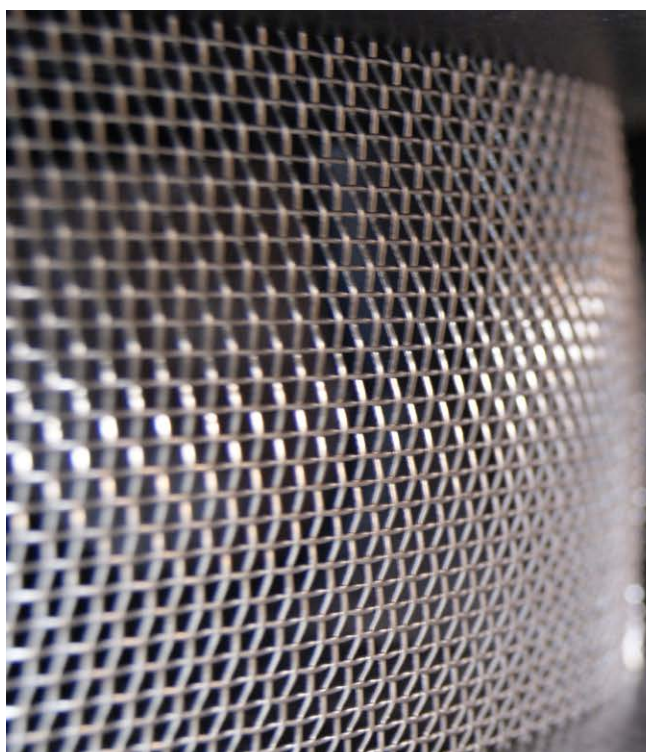

THIS IS WHAT YOU GET

- Minimized cost of services and maintenance during the systems life span.
- Less power consumption (therefore greater energy autonomy and less accumulation of heat in the electronic components of the system).
- Working 24 / 7 / 365 (No need for thermal auto shutdown during vital emergencies).
- Lower weight and height give less wind load, smaller mast and lower installation costs.
- Comes with the most powerful speaker drivers in the market.
- Greater reliability thanks to important components such as amplifiers, drivers and batteries.

Weights and measures



Modelo	SPL @ 1 m	SPL @ 30 m	System wattage Audio tone	Voice audio	Hight cm (inches)	Width cm (inches)	Weight kg (lbs.)
TWS-291	139 dB(C)	109 dB(C)	400	500	51.8 (20.4)	84.8 (33.4)	48.6 (107)
TWS-292	145 dB(C)	115 dB(C)	800	1000	83.6 (32.9)	84.8 (33.4)	70.8 (156)
TWS-293	149 dB(C)	119 dB(C)	1200	1500	115.3 (45.4)	84.8 (33.4)	93 (205)
TWS-294	151 dB(C)	121 dB(C)	1600	2000	147.1 (57.9)	84.8 (33.4)	115.3 (254)
TWS-295	153 dB(C)	123 dB(C)	2000	2500	178.8 (70.4)	84.8 (33.4)	137.5 (303)
TWS-296	155 dB(C)	125 dB(C)	2400	3000	210.6 (82.9)	84.8 (33.4)	164.2 (362)
TWS-297	156 dB(C)	126 dB(C)	2800	3500	242.3 (95.4)	84.8 (33.4)	186.5 (411)
TWS-298	157 dB(C)	127 dB(C)	3200	4000	274.1 (107.9)	84.8 (33.4)	208.7 (460)
TWS-299	158 dB(C)	128 dB(C)	3600	4500	305.8 (120.4)	84.8 (33.4)	230.9 (509)
TWS-2910	159 dB(C)	129 dB(C)	4000	5000	337.6 (132.9)	82.5 (32.5)	253.1 (558)

Cabinets	Hight cm (inches)	Width cm (inches)	Depth cm (inches)	Weight kg (lbs.)
Electronics cabinet** (TWS-291-295)	84.5 (33.3)	58.0 (22.8)	35.0 (13.8)	_*
Electronics cabinet** (TWS-296-2910)	169.0 (66.6)	58.0 (22.8)	35.0 (13.8)	_*

* Less batteries. Two batteries: 12 V, sealed, lead-calcium, add 24 kg pr. battery. Less optional radio kit. Add 2.5 kg, if this option is selected.

Weight depends on model siren, verify weight in the technical data sheet of the specific equipment.

** Equipment is configured for 120 Vac input power. Other input Voltages supplied upon request.

Masts

DESIGN – TOWER AND MAST

In accordance with local regulations and standards



SIMPLE DESIGN

EASY TO INSTALL



ACCESSORIES FOR THE TWS-SERIES

HIGH INTENSITY

VISUAL ALERT

SUPER-LED VISUALERT

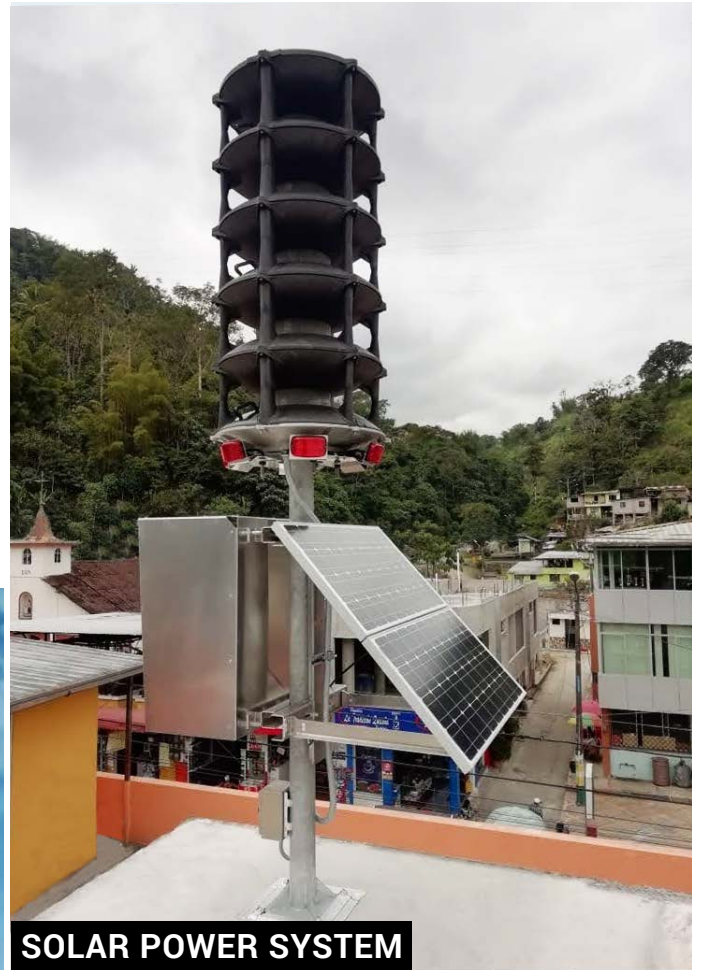

SOLAR POWER SYSTEM

- DESIGNED FOR

HARSH ENVIRONMENTS

The TWS-SBC200 is an all-inclusive solar power supply solution engineered to meet the power requirement of a TWS-Siren or Giant Voice® PA/GA system. High quality components and UV resistant cabling ensure years of performance even in harsh environments. Solar panels with tempered glass and excellent low light power output combined with 3-Stage intelligent PWM charging ensure high efficiency charging performance. Simple yet flexible aluminium mounting bracket for easy panel angling and installation.

VISUAL LED WARNING

Enhance your Voice and Siren Mass Notification System with an optional visual component: The omni-directional visual lighting for TWS-290 & OA Series.

- VisuAlert Super-LED® mounts under a TWS-290 or omni-alert system
- Complete 360° highly effective LED warning
- VisuAlert illuminates with a designed flash pattern when siren is activated
- Cluster of six LED Whelen M6 Series warning lighthoods, 24 VDC
- Bracket supports are 300 Series aluminium alloy in a high strength
- All connections are waterproof

TWS-290 Series. Mass notification solution

TWS-SERIES HAS THE BEST PERFORMANCE IN THE MARKET

SPECIALISTS

IN CUSTOMIZED WARNING

SYSTEM SOLUTIONS



PERFORMANCE

- Maximum acoustic and energy performance
- Highest SPL sound output compared to power consumption
- True 360° omnidirectional sound propagation without any acoustic shadows
- Proven MTBF of more than 30,000 hours
- Lowest maintenance and service requirements
- Modular design made of robust fiber-reinforced polycarbonate
- High efficiency EZ-PULL™ speaker drivers
- Normal amplifier output power 400 Watts during tone / 500 Watts during voice
- Rated total max. output power 600 Watts total capacity per amplifier
- Intelligible pre-recorded or live voice messages in a wide area
- STI intelligibility index 0.98
- A single amplifier for each high efficiency speaker driver
- Tested for decades in all types of climate and environments with success

COMMUNICATIONS

- Multiple technologies
- Simple or redundant
- VHF UHF digital radio
- Radio trunking
- GPRS 3G 4G
- Satellite BGAN M2M
- Broadband Networks
- IP Ethernet / Fiber Optic

POWER

- Operation with AC, DC or solar energy
- Less power consumption = greater autonomy in emergencies
- Less excess heat in the electronics cabinet
- Minimum autonomy 30 minutes of continuous activation
- No need for thermal auto shutdown during vital emergency alerts
- Separate ventilated battery compartment

TWS-290 Series cabinet

A RELIABLE, LOW COST WARNING AND INFORMATION SYSTEM

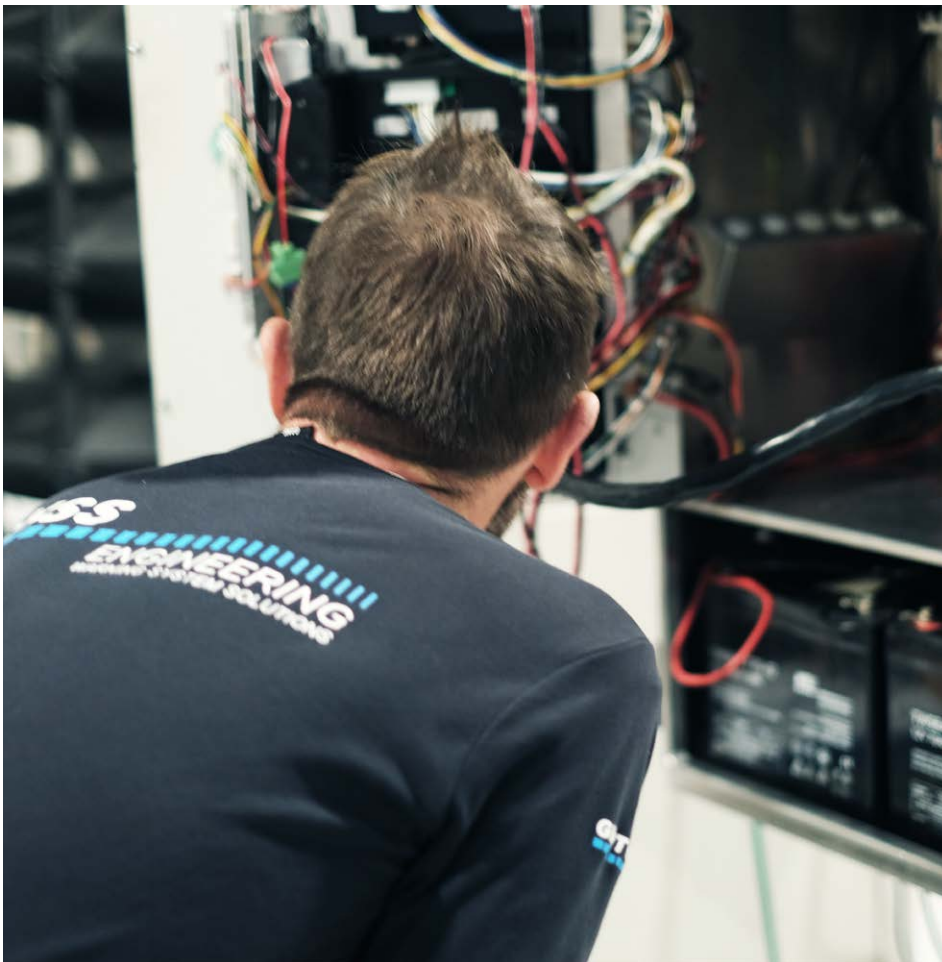

PERFORMANCE

- Maximum acoustic performance
- Six standard public warning tones - Wail, Whoop, Attack, Hi-Lo, Alert, Airhorn
- SI TEST®
- Lightning arrestor / Intrusion alarm
- Tone generator / Timer function
- Public address capability
- Local controls and/or remote controls

DESIGN

- Two compartment natural finish aluminum cabinet with battery tray
- Battery switch
- Electronic siren controller
- Robust and light weight
- Lower weight and height
- Less wind load
- Easy to install
- High quality IP66 electronics cabinet



A 12 V valve-regulated lead-acid (VRLA) battery for the TWS-290 Public Warning System



TWS BATTERY 100-12

TWSBATT 100-12

TECHNICAL DATA

Nominal voltage	12 V	
Nominal capacity (10HR)	100 AH	
Dimensions	Length:	330 mm (12.99")
	Width:	173 mm (6.81")
	Container height:	212 mm (8.35")
	Total height:	220 mm (8.66")
Weight	Approx. 28.5 kg (62.8 lbs.)	
Terminal size	Ø 8 mm	

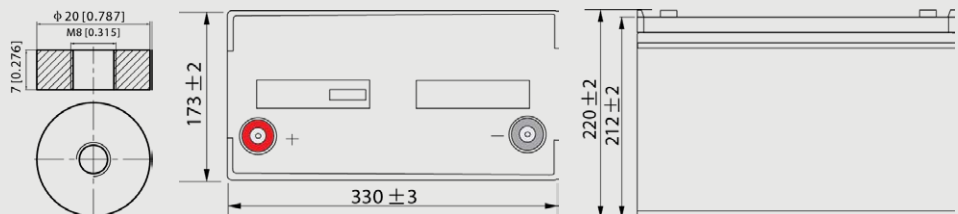

HSS

HSS Engineering A/S
 Laegaardsvej 12 · 8520 Lystrup · Denmark
 Phone + 45 7022 8844
 www.hss.dk · info@hss.dk

ENGINEERING®
 WARNING SYSTEM SOLUTIONS



HSS

ENGINEERING®
WARNING SYSTEM SOLUTIONS

DISASTERS HAPPEN, BE PREPARED



TRANSPORT INFORMATION

UN No: 2800

Package group: III

IATA: Not restricted for air transport-complies Special Revision A67

IMO: Not classified as of 1922

Required Label NON-SPILLABLE

Unrestricted U.S.A. shipment.
Complies with IATA/ICAO Special Provision A67 for air transport.
Recognized by DOT as "Dry Charge"
49 CFR 171-189 for surface transport.
Classified per MG Amendment 27 as a non-hazardous material for water transport.

TECHNICAL DATA

Terminal	M8
Container material	ABS
Rated capacity	100.0 AH / 10.0 hr (10 hr, 1.80 V/cell, 25° C / 77°F)
Max. discharge current	1200 A (5s)
Internal resistance	Approx. 4.8 mΩ
Temp. range	Standard operating: -15–50° C (5–122°F) When paired with our temp. compensating charger TWS-BATTCH: Extended Operating: -35–60° C (-31–140°F)
Cycle use	Initial Charging Current less than 30.0 A. Voltage 14.4 V–15.0 V at 25° C (77°F) Temp. Coefficient -30 m V/° C
Standby use	No limit on Initial Charging Current Voltage 13.5 V–13.8 V at 25° C (77°F) Temp. Coefficient -20 mV/° C
Capacity affected by temperature	40° C (104°F) 25° C (77°F) 0° C (32°F) 103% 100% 86%
Self-discharge	TWSBATT 100-12 battery's may be stored for up to 6 months at 25° C (77°F) before a recharge is required. For higher temperatures the time interval will be shorter.

ORDERING INFORMATION

Product Description

TWS Battery AGM 12 V 100 Ah

Order No.

TWSBATT 100-12

REV. F

HSS

ENGINEERING®
WARNING SYSTEM SOLUTIONS

HSS Engineering A/S
Laegaardsvej 12 · 8520 Lystrup · Denmark
Phone + 45 7022 8844
www.hss.dk · info@hss.dk



HSS

ENGINEERING®
WARNING SYSTEM SOLUTIONS

*Solar power
system designed
for harsh
environments*



SOLAR POWER SYSTEM

TWS-SBC200

The TWS-SBC200 is an all-inclusive solar power supply solution engineered to meet the power requirement of a TWS-Siren or Giant Voice® PA/GA system. High quality components and UV resistant cabling ensure years of performance even in harsh environments. Solar panels with tempered glass and excellent low light power output combined with 3-Stage intelligent PWM charging ensure high efficiency charging performance. Simple yet flexible aluminium mounting bracket for easy panel angling and installation.

FEATURES

- Panel performance guarantee, 90% for 10 years & 80% for 25 years
- Panels with tempered glass and class A cells with + 3% plus tolerance
- Panels feature bypass diodes for shadow optimization at serial connection
- 3-Stage intelligent PWM charging, bulk, boost/equalize, float
- Battery status LED indicator
- Extensive electronic protection – over voltage, over discharge, reverse polarity etc.
- Mounting bracket made of EN AW-5754 aluminium ensures extremely high corrosion resistance
- Solar feed cable featuring MC4 connectors is Weather/UV-resistant acc. to HD 605/A1, halogen-free and flame-retardant

HSS

ENGINEERING®
WARNING SYSTEM SOLUTIONS

HSS Engineering A/S
Laegaardsvej 12 · 8520 Lystrup · Denmark
Phone + 45 7022 8844
www.hss.dk · info@hss.dk



**DISASTERS
HAPPEN, BE
PREPARED**



ORDERING INFORMATION

Product Description

Solar power system 2 x 12V
100 Watt panels

Order No.

TWS-SBC200

REV. E

TECHNICAL DATA PER SOLAR PANEL

Power	100 Watt*
Panel voltage	12 Volt
Number of bypass diodes	2 pcs.
Max. power current (Imp)	5.68 A
Open circuit voltage (Voc)	21.6 V
Short circuit current (Isc)	6.14 A
Max power tolerance	-/+ 3%
Dimensions (pr. panel)	Width: 1200 mm (47,24") Height: 540 mm (21,26") Depth: 35 mm (1,37")
Panel weight (pr. panel)	8.2 kg

INCLUDES

- 2 x 100 Watt* solar panels
- PWM solar charge controller
- TWS/GV power supply interface
- Mounting bracket for solar panels (weight 9.1 kg)
- Siren controller interface cable
- 15 meter solar feed cable

* Solar panels can be with higher power output for customer requirements.

HSS Engineering A/S
Laegaardsvej 12 · 8520 Lystrup · Denmark
Phone + 45 7022 8844
www.hss.dk · info@hss.dk

HSS



ENGINEERING®
WARNING SYSTEM SOLUTIONS



GIANT VOICE®

EMERGENCY SYSTEMS



*Basic unit incl.
GV-EMS
software*

CORE UNIT GV-CORE-RM3

The Giant Voice® Core Unit serves as the integration platform for Giant Voice® products as well as auxiliary components. It connects directly to the Giant Voice® Distributed Communication Network (GV-DCN). All components are chosen to ensure the highest reliability reducing maintenance to a minimum.

The Giant Voice® Core Unit features a multi I/O communications interface, which enables easy connection and control of classic analogue DTMF systems as well as digital radios, PA-microphone, LAN and fibre etc. Moreover, it has a built-in audio distribution interface, which provides connection to devices such as CD-Players, PA systems etc. and from here distributed throughout the control interface.

The built-in dual voltage 115/230 VAC power supply combined with the multi I/O communications interface ensures a high level of flexibility for installation.

FEATURES

- Highly Versatile Communications Interface
- Advanced siren system fault monitoring and control features via GV-EMS software
- Backwards compatible TWS, Giant Voice and Whelen DTMF Control Interface
- Dual Voltage 115/230 VAC
- 19" 3U cabinet design
- CD-Players, PA systems etc distributed throughout the control interface
- Components chosen to ensure the highest reliability

HSS

ENGINEERING®
WARNING SYSTEM SOLUTIONS

HSS Engineering A/S
Laegaardsvej 12 · 8520 Lystrup · Denmark
Phone + 45 7022 8844
www.hss.dk · info@hss.dk



GIANT VOICE®

EMERGENCY SYSTEMS



ALERTS PEOPLE TO POSSIBLE DANGER



ORDERING INFORMATION

Product Description

Core Unit

Order No.

GV-CORE-RM3

Product Description

Giant Voice® EMS

Order No.

GV-EMS

Option

Product Description

Telecom System Interface

Order No.

GV-PABX-A (Analogue)

GV-PABX-D (Digital)

REV. C

TECHNICAL DATA

DTMF Port	1
Digital Communications Port	1
Optional/Audio Port	1
LAN Ports	2
Display Port	1
DVI-I	1
COM Ports	2
USB Ports	7
PABX Expansion Slots	1
Operating temperature	-10° C – +60° C
Dimensions	Width: 19" (48,26 cm) Height: 3U Depth: 32,25 cm (12.69")
Weight	5,35 kg
Dual Voltage	115/230 VAC
Max power consumption	100 Watt



OPTIONS

GV-PABX-A Telephone Branch Exchange Interface-Analogue

GV-PABX-D Telephone Branch Exchange Interface-Digital

Please contact us for more details.

HSS

HSS Engineering A/S
Laegaardsvej 12 · 8520 Lystrup · Denmark
Phone + 45 7022 8844
www.hss.dk · info@hss.dk

ENGINEERING®
WARNING SYSTEM SOLUTIONS

GIANT VOICE®

EMERGENCY SYSTEMS



*A comprehensive
and flexible
emergency
system*



EMERGENCY MANAGEMENT SYSTEM GV-EMS

The system is scalable i.e., the user can access all data and information, or activate components on the system from any GV-CORE unit connected to the system.

The software can be operated from one or more screens displaying different menus simultaneously. Menus are predesigned for touch screen operation. The system can be configured to meet your specific needs, such as predefined warning tones, pre-recorded messages and sequences, as well as customer-selected maps of the area.

The GV-EMS is a comprehensive and flexible Emergency System providing easy and understandable information that enables the user to make the right decisions and to react within seconds.

The GV-EMS has been developed to meet the customers' need for precise and accurate information at hand, when vital decisions must be made.

The software is delivered preinstalled on the GV-CORE unit that serves as the platform for the Giant Voice® Distributed Communication Network (GV-DCN).

The system is easy to use with its straightforward logic - simply select the system components on the map and then choose your action from one of the on-screen menus.

You can also add predefined sequences to the system by assigning sequences to the programmable activation keys. A sequence is defined by any specific warning priority, such as an alert by tones and inform by a public announcement.

You will not encounter any language barriers and the user interface can be modified with easily recognizable icons and colors.

HSS

HSS Engineering A/S
Laegaardsvej 12 · 8520 Lystrup · Denmark
Phone + 45 7022 8844
www.hss.dk · info@hss.dk

ENGINEERING®
WARNING SYSTEM SOLUTIONS



GIANT VOICE®



EMERGENCY SYSTEMS

**ALERTS
PEOPLE TO
POSSIBLE
DANGER**



INTEGRATION TO

- SCADA
- CCTV
- Fire System
- Warning Systems and more

MAP FEATURES

- Zoom and pan capability
- Orientation map
- Predefined group selection
- Printable maps

ACTIVATION FEATURES

- Activation of selected system components
- Activation status display
- Activation accept allows to preview the command before transmission

SERVICE FEATURES

- Status data request from selected system components (for example: battery status, speaker driver or amplifier failure, AC Power, cabinet temperature)
- Real-time status monitoring

ANALYSIS FEATURES

- User defined analysis criteria (Period, Selected Sirens, Command Type etc.)
- Data base of status logs with capability of storing information
- Export data function enabling export of selected data to e.g. Microsoft Excel

FEATURES

- IP-Broadcast
- Unlimited amount of programmable predefined sequences
- Supports colour coded system components icon
- Configuration, monitoring and control capability of all system components in real-time
- Integration platform for a variety of components such as public address, general alarm sirens, PABX, sensors, strobe lights, text displays, SMS text message and more
- Individual Log-On ID supporting differentiation between operators, service personnel and administrators
- Supports GV-DCN network structure

OPTIONS

- PABX Integration Additional screens
- 10 digit DTMF protocol
- Email Warning
- Giant Voice® Radio Base Station (UHF/VHF)
- Rack cabinet enclosure as pr. customer requirements
- SMS Warning

HSS



ENGINEERING®
WARNING SYSTEM SOLUTIONS

HSS Engineering A/S
Laegaardsvej 12 · 8520 Lystrup · Denmark
Phone + 45 7022 8844
www.hss.dk · info@hss.dk

GIANT VOICE®

EMERGENCY SYSTEMS

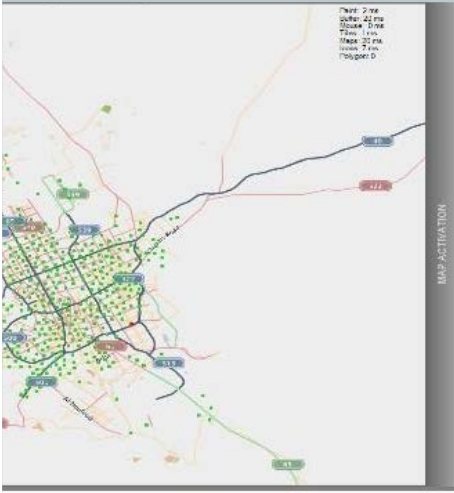

A 19" touch screen for the Giant Voice® emergency management system



TOUCH SCREEN GV-TS19

The GV-TS19 Touch Screen is based on projected capacitive technology that, thanks to a glass overlay covering the screen, guarantees high durability, scratch-resistance and perfect picture performance. The touch function remains unaffected even if the glass is scratched.

A solid and steady base supports the Touch Screen with an adjustable stand offering full 90 degree positioning angles. Menu Buttons are located on the side of the screen, that can be locked to prevent tampering and includes a handy function to deactivate the Touch Screen for cleaning.

In addition, the edge-to-edge glass design creates an eye-catching finish, with high light transmission guaranteeing perfect picture clarity and brilliant colours. Analogue and Digital inputs are available for flexible connectivity along with a USB port for the Touch Interface.

SPECIFICATIONS

Power supply	AC 100 - 240 V, 50 / 60 Hz
Power supply unit	Internal
Power consumption	25 W typical; max. 2 W in power management mode
Power management	VESA DPMS
Analog input connector	VGA
Digital input connector	HDMI Display Port
Inputs	USB (for touch connectivity)
Dimensions	Width: 432 mm Height: 391 mm Depth: 219 mm Weight: 6,9 kg

HSS

ENGINEERING®
WARNING SYSTEM SOLUTIONS

HSS Engineering A/S
Laegaardsvej 12 · 8520 Lystrup · Denmark
Phone + 45 7022 8844
www.hss.dk · info@hss.dk



GIANT VOICE®

EMERGENCY SYSTEMS



ALERTS PEOPLE TO POSSIBLE DANGER



ORDERING INFORMATION

Product Description

Giant Voice® 19" Touch Screen

Order No.

GV-TS19

Options

Product Description

Rackmount Bracket
for 19" Touch Screen

Order No.

GV-TSRMB

REV. F

DISPLAY CHARACTERISTICS

Panel	IPS LED
Glass hardness	7H minimum
Display area	Height: 302.0 mm (11.89") Width: 377.5 mm (14.86") Response time 5 ms / 14 ms
Contrast	1000: 1 with touch panel
Brightness	225 cd/m² with touch panel
Viewing zone	Horizontal/vertical: 178° / 178° Right/left: 89° / 89°; up/down: 89° / 89°
Display colour	16.7 million
Pixel pitch	0.2928 mm
Native resolution	1280 x 1024 (1.3 megapixel)
Horizontal sync	31 - 80 KHz
Vertical sync	50 - 75 Hz
Synchronization	Separate Sync
Aspect ratio	5 : 4
Light transmittance	90%

HSS

ENGINEERING®
WARNING SYSTEM SOLUTIONS

HSS Engineering A/S
Laegaardsvej 12 · 8520 Lystrup · Denmark
Phone + 45 7022 8844
www.hss.dk · info@hss.dk

Protect your
Giant Voice® System
from power outages

GIANT VOICE®

EMERGENCY SYSTEMS

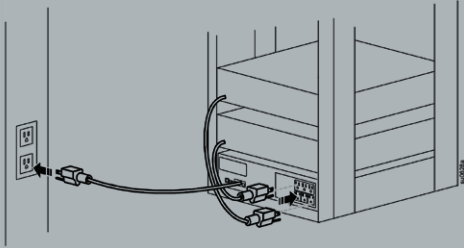

UPS GV-UPS1500

The GV-UPS contains a battery pack that ensures operation of critical components in your PA/GA system in case of a power outage. The module is designed specifically for use together with the Giant Voice® PA/GA product range and is easily installed in racks along with these components.

The GV-UPS is equipped with 4 x IEC 230 VAC outlets and support loads 900 Watt. For extended battery capacity, more units can be added.

FEATURES

- 2U rack case with rack rails
- 4 x IEC 230 VAC outlets
- Supports 900 Watt / 1500 VA
- True Sinewave output (THD<3%)
- High efficiency up to 92%
- Thermostatically controlled fan

HSS

HSS Engineering A/S
Laegaardsvej 12 · 8520 Lystrup · Denmark
Phone + 45 7022 8844
www.hss.dk · info@hss.dk

ENGINEERING®
WARNING SYSTEM SOLUTIONS



GIANT VOICE®

EMERGENCY SYSTEMS



**DISASTERS
HAPPEN, BE
PREPARED**



ORDERING INFORMATION

Product Description

1500 VA UPS

Order No.

GV-UPS1500

REV. E

SPECIFICATIONS

Rated AC power output	900 Watt
Number of 230VAC outlets	4
Transfer time	10 ms
Power supply	230 VAC, 50/60 Hz
Battery Volt-Amp-Hour capacity	336
Dimensions	Width: 43.2 cm (17.0") Height: 2U (8.6 cm) Dept: 47.7 cm (18.8") Weight: 28.6 kg
Operating temperature	0 - 40° C

1500 VA 230 VAC

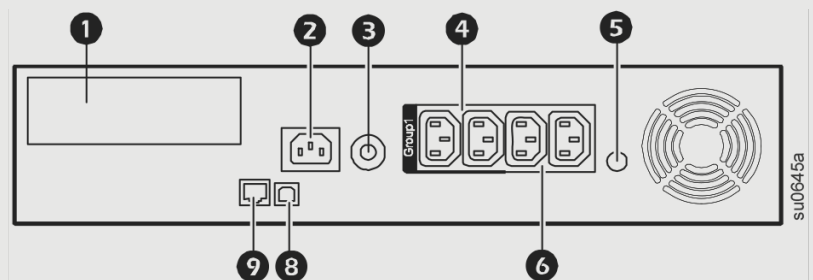

HSS

HSS Engineering A/S
Laegaardsvej 12 · 8520 Lystrup · Denmark
Phone + 45 7022 8844
www.hss.dk · info@hss.dk

ENGINEERING®
WARNING SYSTEM SOLUTIONS



GIANT VOICE®

EMERGENCY SYSTEMS

*The rack
is a solution for
your emergency
warning system*



RACK GV-RACK

The GV-RACK incorporates common features, such as adjustable 19-inch mounting angles and jacking feet, the GV-RACK range offers a configurable top panel system that provides an open base design to promote trouble free service and maintenance.

The GV-RACK is designed to provide the flexibility needed to suit all requirements of your Giant Voice® Emergency Management System. The rack can be fitted with options such as a top active fan and SMART UPS.

The GV-RACK is built to high quality standards.

FEATURES

- Environmental protection rating IP20
- Adjustable 19-inch mounting rails
- Upgradable plain top panels
- Open base design
- Glazed front door and plain steel rear door
- Lockable lift off side panels
- Jacking feet fitted as standard
- Cable inlet apertures in both top and bottom
- Key lock on sides and rear. Key and handle lock on front



HSS

HSS Engineering A/S
Laegaardsvej 12 · 8520 Lystrup · Denmark
Phone + 45 7022 8844
www.hss.dk · info@hss.dk

ENGINEERING®
WARNING SYSTEM SOLUTIONS



GIANT VOICE®

EMERGENCY SYSTEMS



HSS ADVANCED WARNING SYSTEMS

ORDERING INFORMATION

Product Description

RACK

Order No.

GV-RACK-15U
GV-RACK-22U
GV-RACK-36U
GV-RACK-42U

Product Description

Top active fan

Order No.

GV-RACK-FAN

Product Description

SMART UPS

Order No.

UPS 1500VA
UPS 3000VA*

* Requires a rack depth of 1000 mm
REV. F

TECHNICAL DATA

Air Flow	95 -115 CFM			
Fan Speed	2700 - 3100 rpm			
Noise level	44-49 db/A			
Operating Voltage	220-240V, 50-60 Hz			
Complies with	IEC 297-1			
Dimensions	15 U	22 U	36 U	42 U
Width	600 mm	600 mm	600 mm	800 mm
Height	815 mm	1120mm	1728 mm	2400 mm
Depth	680 mm	800 mm	800 mm	800 mm
Color	Light Grey NCS 1502-Y			

OPTIONS

- Smart UPS 1500 VA, 3000 VA*
- Other dimensions and colors are available on request

HSS

ENGINEERING®
WARNING SYSTEM SOLUTIONS

HSS Engineering A/S
Laegaardsvej 12 · 8520 Lystrup · Denmark
Phone + 45 7022 8844
www.hss.dk · info@hss.dk

Satellite &
Cellular Communication
Solutions

GIANT VOICE®

EMERGENCY SYSTEMS

DUAL MODE BGAN M2M

This terminal is the only Inmarsat BGAN M2M terminal to offer dual mode operation, which provides unique flexibility and M2M data communication cost-control, as it ensures the most cost effective communication service that can be chosen, depending on location.

Securing continuity of M2M IP data transfer, often originating in hard to reach, remote locations, dual-mode operation delivers significant fail-over capabilities with automatic switching between BGAN and cellular networks.

For organizations transferring critical real time data within their M2M networks, the dual mode can provide unmatched service availability. The terminal is well suited for bespoke M2M solutions such as IP SCADA for data backhaul, asset tracking, real time surveillance and remote telemetry.

SATELITE SOLUTION

Dual Mode BGAN M2M & Cellular terminal GV-SAT

HSS Engineering has designed a satellite & cellular communication solution ideal for monitoring, activation and interaction with the TWS Siren and GV-EMS systems. These systems function in areas with a lack of communication due to geographical conditions, using BGAN M2M technology terminal designed to operate on both Inmarsat BGAN (Broadband Global Area Network) and cellular 2G/3G/LTE networks. GV-SAT delivers continuous and reliable connectivity for critical monitoring and control applications.

BGAN M2M services use Inmarsat BGAN to provide a reliable, global, two-way IP data service. It is designed to connect monitoring and control applications in remote, unmanned locations, providing asset visibility and management control. By combining BGAN M2M with cellular connectivity in the same terminal, GV-SAT gives users the opportunity to choose the best carrier for any location.



HSS

HSS Engineering A/S
Laegaardsvej 12 · 8520 Lystrup · Denmark
Phone + 45 7022 8844
www.hss.dk · info@hss.dk

ENGINEERING®
WARNING SYSTEM SOLUTIONS

GIANT VOICE®

EMERGENCY SYSTEMS



FEATURES

- GV-SAT is BGAN M2M certified and BGAN Class 2 Type Approved for services such as BGAN Link
- Lightweight and rugged IP66 design ensures durability for outside mounting - no enclosure needed
- Polemount included in the package
- Simple to set up and operate
- Versatile power options with both Power over Ethernet (PoE) and 10-32 VDC input
- Two cable glands for easy installation of standard power and Ethernet cables into the back housing
- Remote management of the terminal via SMS including configuration, debugging, and access to the web interface
- The optional cellular 2G/3G/LTE Modem is an integrated part of the design
- Automatic failover between BGAN and the cellular network ensures continuous connectivity
- Connectivity in North, Central & South America, Europe, Asia, Africa and more

TECHNICAL DATA

Dimensions (H x W x D)	Mainn Unit: 202 x 202 x 51.8 mm
Weight	Total: 1.4 kg
Standard IP	Up to 464 kbps
Streaming IP	32, 64, 128 kbps (not in M2M mode)
Connectivity	1 x Micro USB interface (for EXPLORER 3G modem) 1 x RJ45 Ethernet interface with PoE 1 x 8 pin Ethernet interface 1 x 3 pin for I/O 1 x 2 pin for DC power input
Operating Temperature	-40 °C – +75° C Storage
Temperature	-55 °C – +80° C Ingress Protection IP66
DC Input range	10.5-32 VDC Languages: ENG, FR, DE, ES, RU, JP and CN
DC input range	10.5-32 VDC Pin Connector
PoE input	Poe+ IEEE 802.3 at Type 2 Class 4 via RJ45 Connector

ORDERING INFORMATION

Product Description

Giant Voice® Satellite Solution

Order No.

TWS-SAT

NOTE: The TWS-SAT Solution Frequency to be determined at order.
Please contact HSS Engineering for further information

REV. D

HSS

ENGINEERING®
WARNING SYSTEM SOLUTIONS

HSS Engineering A/S
Laegaardsvej 12 · 8520 Lystrup · Denmark
Phone + 45 7022 8844
www.hss.dk · info@hss.dk

EMERGENCY MANAGEMENT SYSTEMS

Fast activation

Choose area on map

Rectangle selection

Circle selection

Free selection

Select all

Save

Delete

2. Choose communication



Activate

Are you sure?
Do you want to activate the alert?
Please confirm below

Confirm

Cancel

HSS

ENGINEERING®
WARNING SYSTEM SOLUTIONS

WE CUSTOMIZE COMPREHENSIVE AND FLEXIBLE EMERGENCY SYSTEMS

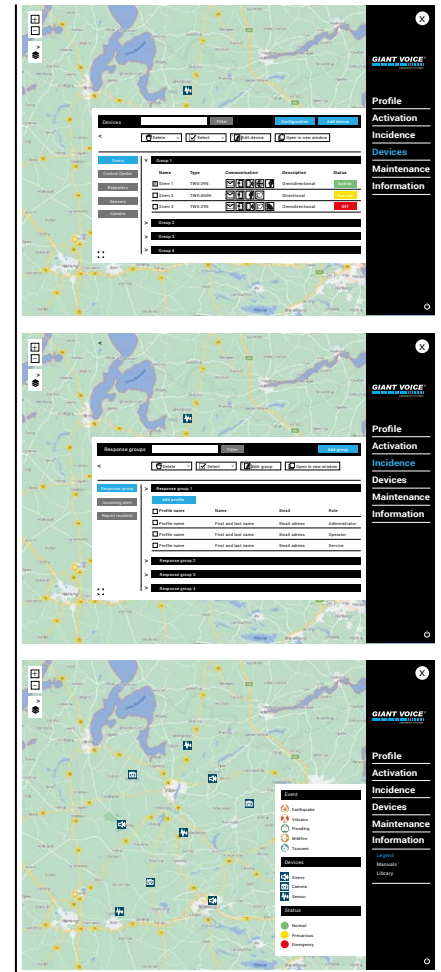
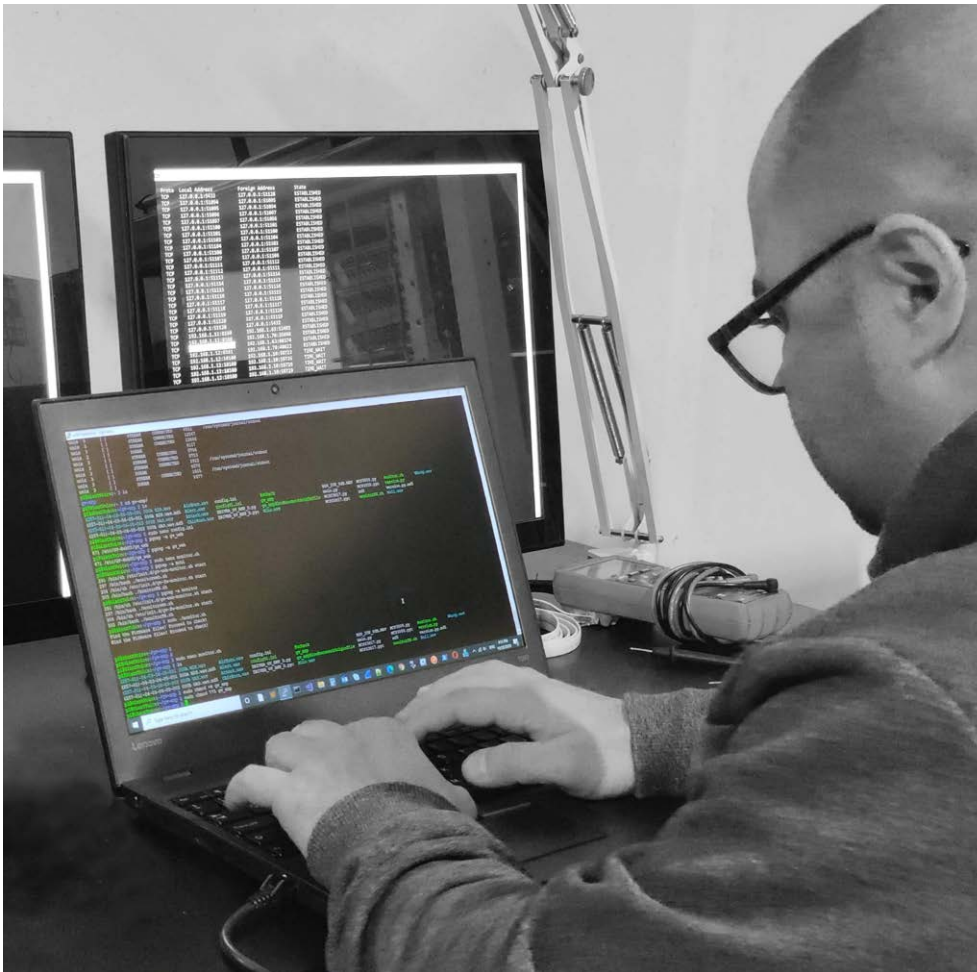

The GV-EMS is a comprehensive and flexible Emergency System providing easy and understandable information that enables the user to make the right decisions and to react within seconds.

The GV-EMS has been developed to meet the customer's need for precise and accurate information at hand, when vital decisions must be made. GV-EMS network structure is designed in a flat hierarchical structure. Working independently or in groups.

The software is delivered preinstalled on the GV-CORE unit that serves as the platform for the Giant Voice® Distributed Communication Network (GV-DCN).

The system is easy to use with its straightforward logic - simply select the system components on the map and then choose your action from one of the on-screen menus.

You can also add predefined sequences to the system by assigning sequences to the programmable activation keys. A sequence is defined by any specific warning priority, such as an alarm (tones) or a public information.

You will not encounter any language barriers and the user interface can be modified with easily recognizable icons and colors.

GV-EMS. Emergency Management System

**GV-EMS MEETS
INTERNATIONAL
STANDARDS AND IT IS
COMPATIBLE TO ANY
COMMON ALERT
PROTOCOL**



INTEGRATION TO ANY DEVICE

- Sensoring systems
- CCTV systems
- Fire detection Systems
- Weather Station and more
- Unlimited amount of devices can be integrated

MAP FEATURES

- Predefined static map
- Zoom capability
- Rectangle, circle, groups and free selection of devices
- Map formats: JPEG, PNG, SHP, DBF, JSON, GEOjson and SHX format

ACTIVATION FEATURES

- Activation of selected system components
- Activation status display
- Activation accept allows to preview the command before transmission

SERVICE FEATURES

- Status data request from selected system components (for example: status, speaker driver or amplifier failure, AC Power, cabinet temperature)
- Real-time status monitoring for any type of RTU device or repeater station

ANALYSIS FEATURES

- User defined analysis criteria (Period, Selected Sirens, Command Type etc.)
- Data base of status logs with capability of storing information in any format
- Export data function enabling export of selected data to e.g. Microsoft Excel

FEATURES

- Live voice message through IP-Broadcasting, radio VHF/UHF, etc.
- Unlimited number of programmable predefined sequences
- Predesigned menus for touch screen operation
- Interactive icons and symbols
- Configuration, monitoring and control capability of all system components in real-time
- Integration platform for a variety of components such as public address, general alarm sirens, PABX, sensors, strobe lights, text displays, SMS text message and more
- Individual Log-In ID supporting differentiation between operators, service personnel and administrators in order to secure the system
- Supports GV-DCN network structure
- GV-EMS can manage and monitor devices by any type of communication such as (VHF/UHF) Radio, IP Ethernet, BGAN/Vsat Satellite, GPRS 3G/4G mobile network, EWBS, Digital terrestrial television
- Predefined communication channel management

OPTIONS

- PABX Integration Additional screens
- 10 digit DTMF protocol
- Mobile App
- Repeater station management
- Rack cabinet enclosure as pr. customer requirements
- Mass notification through SMS, Email and IOS / Android compatible mobile App

Step by step.

THIS
IS HOW WE
MAKE IT WORK!

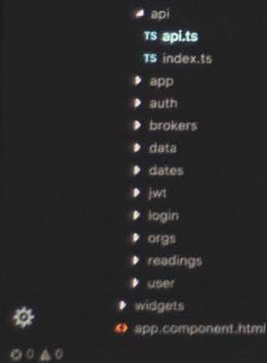

```
Debug Tasks Window Help
api-ts — Edgestack
package.json typings.json tsconfig.json ts api.ts x
weakmap Aa Alt * N
1 import { Injectable, Inject, Injector } from '@angular/core';
2 import { Router } from '@angular/router';
3 import { AuthHttp, JwtHelper } from '../jwt/jwt';
4 import { Observable } from 'rxjs/Rx';
5 import { AuthHelper } from '../auth/auth';
6 import { RequestOptions, Headers, Response } from '@angular/http';
7 import { Config } from '../config';
8 import { appInjector } from '../app/app-injector';
9
10 @Injectable()
11 export class ApiService {
12     jwt: string;
13
14     private static parseResponse(res: Response) {
15         var info = res.headers.get('X-Message-Info');
16         var error = res.headers.get('X-Message-Error');
17         var success = res.headers.get('X-Message-Success');
18         return {
19             message: {
20                 info: info,
21                 error: error,
22                 success: success
23             },
24             json: function() {
25                 let json;
26                 try {
27                     json (local var) Exception: any
28                 } catch (Exception) {
29                     json = res.json();
30                 }
31             }
32         };
33         return json;
34     }(),
35     res: res
36 };
37
38 constructor(
39     public auth: AuthHelper,
40     public authHttp: AuthHttp,
```

HSS



ENGINEERING®
WARNING SYSTEM SOLUTIONS

A full range of high-quality products!

WE SUPPORT YOU ALL THE WAY

A warning system from HSS Engineering® provides a complete alerting and notification system solution that utilizes a variety of technologies, software and hardware that enable municipalities, defense installations and industrial facilities to maintain the safety and security of their personnel and the general public and industrial facilities to maintain the safety and security of their personnel and the general public.

MANUFACTURER OF CUSTOMIZED WARNING SYSTEM SOLUTIONS

At HSS Engineering® we develop, manufacture, deliver, maintain, customize and assemble Giant Voice® and TWS warning system solutions for tailored warning solutions. Our extensive product range and consultancy services ensure that the customer receives a warning solution that addresses their specific safety requirements in a cost-effective and timely manner.

We have challenged our engineers to develop the best technical solutions for a variety of systems. This is why HSS Engineering® currently has an unmatched reputation of providing the best warning system solutions to customers in a global context and with a local perspective.

We have worked successfully with a wide range of customers across North America, Central America, South America, the Middle East, Asia, Europe, and Oceania to provide cost-effective, innovative and customized warning solutions. Throughout our 40 years in business, HSS Engineering® has successfully delivered a variety of projects featuring diverse process technologies to clients around the world.



We are specialists with an exclusive dedication in developing, customizing, manufacturing, delivering and maintaining Public Warning Systems (PWS), Emergency Management Systems (EMS), Public Address & General Alarm systems (PA/GA), defense warning systems as well as turnkey systems.



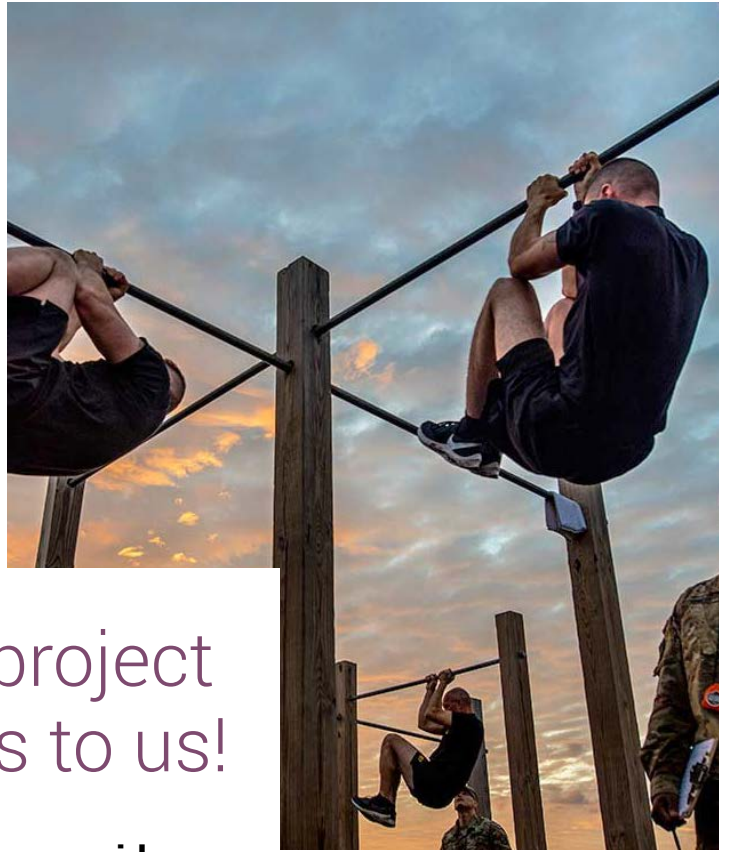

Every project matters to us!

Therefore, we provide a process to satisfy all of our customers.

HSS Engineering® analyzes your needs and provides the best solutions. We do the installation and commissioning and apply our expert knowledge, and offer you support 24/7.

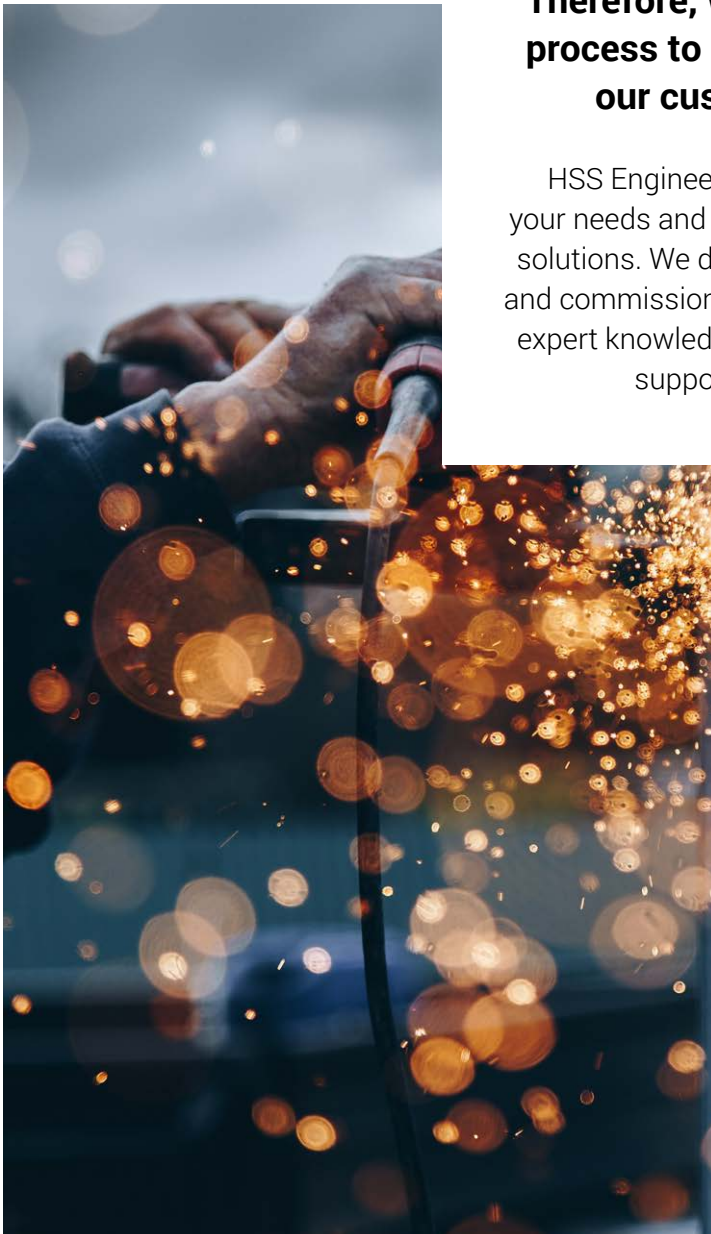

Alerting and notification solutions step by step.

WE ANALYSE YOUR NEEDS

A warning system from HSS Engineering® provides a complete alerting and notification system solution that utilizes a variety of technologies, software and hardware that enable municipalities, defense installations and industrial facilities to maintain the safety and security of their personnel and the general public and industrial facilities to maintain the safety and security of their personnel and the general public.

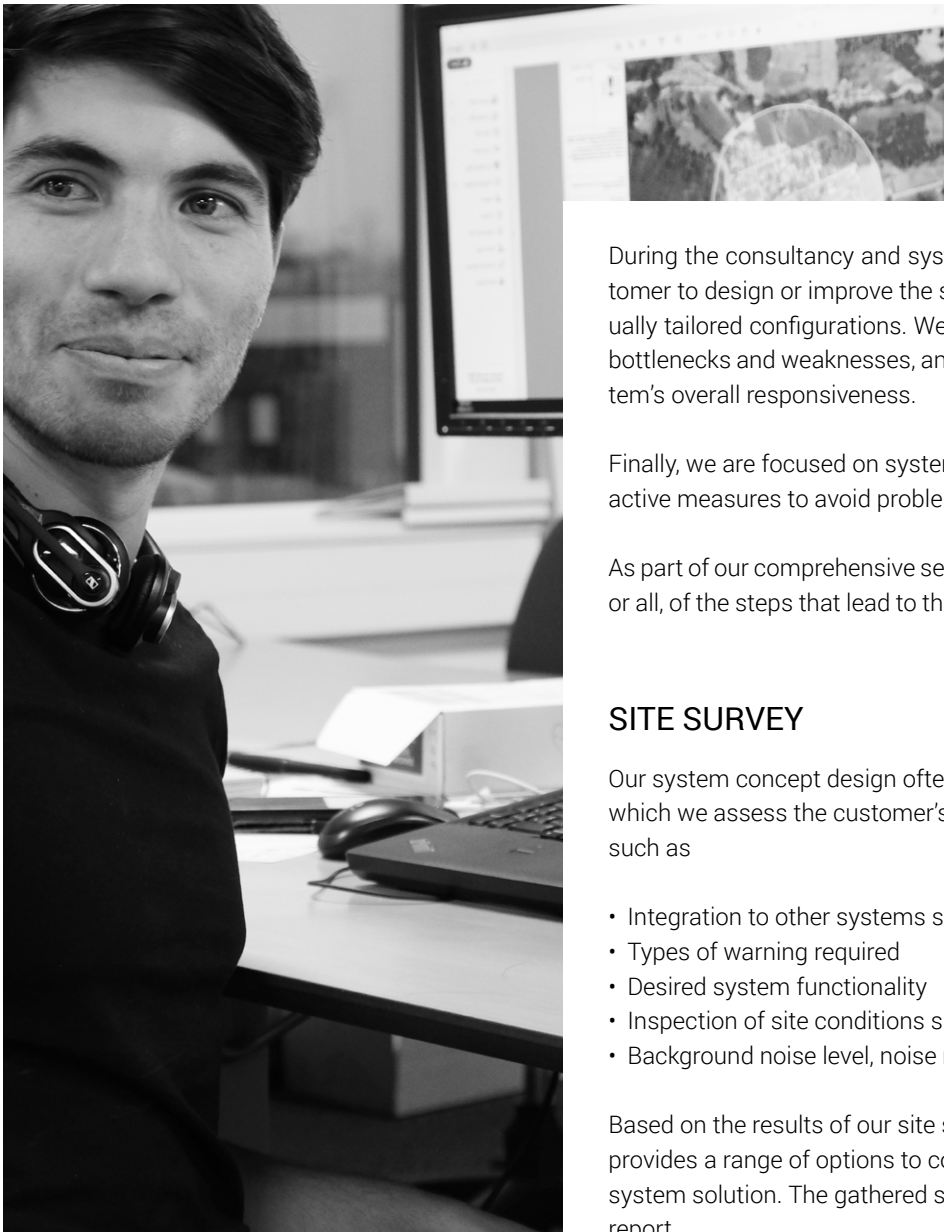

During the consultancy and system design service our engineers help the customer to design or improve the system performance and give advice on individually tailored configurations. We further help our customers to identify system bottlenecks and weaknesses, and suggest courses of action to improve the system's overall responsiveness.

Finally, we are focused on system reliability allowing our customers to take proactive measures to avoid problems, now and into the future.

As part of our comprehensive service, our engineers can be a collaborator in any, or all, of the steps that lead to the design of a new customized warning solution.

SITE SURVEY

Our system concept design often starts with a detailed site survey during which we assess the customer's requirements for the warning system solution such as

- Integration to other systems such as fire and gas, public address, PABX, etc
- Types of warning required
- Desired system functionality
- Inspection of site conditions such as hazardous areas, type of dangers, etc
- Background noise level, noise mapping and acoustic analysis

Based on the results of our site survey, the feedback from our engineers provides a range of options to consider in planning and designing the warning system solution. The gathered survey information is collected into a site survey report.

Alerting and notification solutions step by step.

THE DEVELOPMENT OF A RELIABLE SOLUTION

Several tools and processes are taken into consideration when the HSS Engineering® team is in the process of advising on and designing a system that can resolve all of our customers' warning needs.

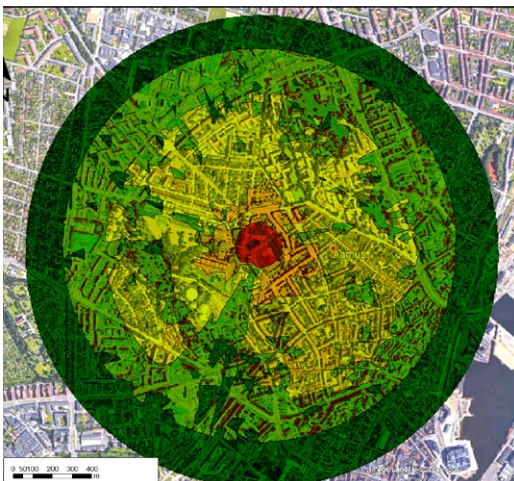

INPUT

Topography, background noise level, information on buildings and structures, siren type, siren output, siren location and siren cluster elevation

SOUNDPLAN

Analysis and calculation

OUTPUT

Graphical presentation, showing siren sound propagation

Action Matrix

The action matrix is a tool that helps identify the types of warning required, their initiation procedure and the area that should be covered by the system. The action matrix procedure requires careful planning and is developed in close corporation with the customers.

Acoustics Simulations and Measurements

To ensure that the warning sound propagation will actually cover the relevant areas, HSS Engineering® offers the services of performing field test measurements. The noise measurements serve as the basis for a noise mapping and acoustical analysis. Creating a noise map gives a comprehensive overview, that in a graphical manner, helps identify weak spots in the sound coverage provided by the warning system.

The sound propagation coverage is compared to the sound levels and coverage areas to ensure that these requirements correspond to the International and local standards and regulations given for the area. The HSS Engineering® team can carry out acoustics simulations and measurements for indoor and outdoor environments.

System Concept Design

Acoustics simulations and measurements can along with the action matrix and other inputs gathered during the site survey be used to make decisions on where and how to install the system. Further more they help designing the interfaces to other external systems.

The system concept design is often kept at a modular level to ensure that the comprehensive overview of the suggested design concept is clear prior to manufacturing and further documentation.

Technical Solution

At HSS Engineering® we go through a thorough process to ensure that we create, the most optimized solutions that are required to meet our customers' needs. We provide a detailed technical and economical explanation of the customers' solutions that can be adjusted according to the customers' feedback.

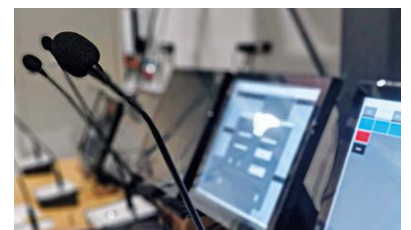

Alerting and notification solutions step by step.

WE PROVIDE THE BEST SOLUTIONS

We develop and provide the most reliable warning solutions.
We are able to customize the solution to meet our customers' requirements.
We handle documentation ranging from simple manufacturing test sheets to construction drawings and wiring diagrams.

FACTORY

ACCEPTANCE TEST

Factory Acceptance Test (FAT) is conducted to determine and document, that the system hardware and software operate according to the customers' specifications.

At HSS Engineering® we consider the factory acceptance test (FAT) to be a very important milestone to;

- Determine and document that hardware / software work according to specifications
- Compare the configuration of the system according to the drawings and documentation
- Test and review the customers' entire operation so that it meets your requirements
- Changes can be identified and incorporated more easily at this stage
- The customer gets the guarantee that each component has been thoroughly tested and verified

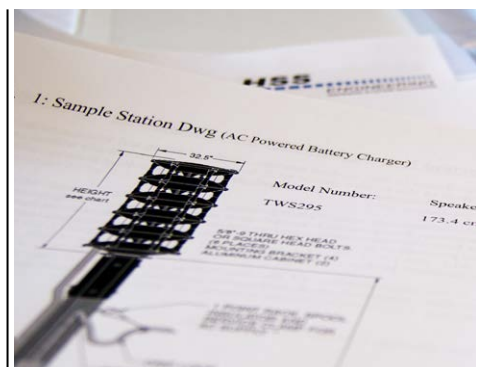
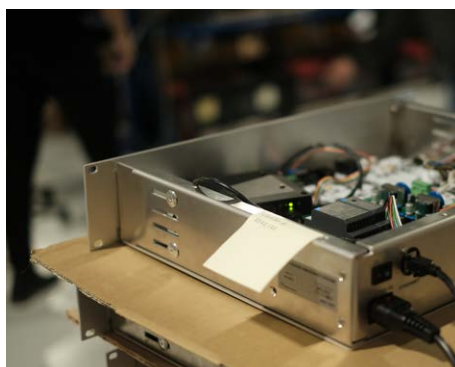

Alerting and notification solutions step by step.

WE DO THE INSTALLATION AND COMMISSIONING

**Our project managers, engineers
and technicians are all seasoned professionals familiar with local
and international industry standards pertaining
to emergency system installations.**

One of the things that sets HSS Engineering® apart from our competitors is that we deploy our own engineers on-site all over the world - including war zones. Our project managers, engineers and technicians are all seasoned professionals familiar with local and International industry standards pertaining to emergency system installation practices for the military, industry and public sectors around the globe. This ensures that we have direct control over the installation process and the ability to fully install, align, test, troubleshoot and commission the system.

Our field engineers receive training in all products each supplementing their specialized competences. This ensures that all field engineers share a common understanding of the system functionality while still maintaining the specialist skills within the deployed crew.

To ensure that all aspects are taken into consideration prior to installation a commissioning plan is laid out between the project manager and the customer to exactly define the system expectations, set a schedule and engage and commit all team members. The effort will be supported by providing the test equipment and knowledge necessary to leave the customer with the assurance that each component has been thoroughly tested and verified.

All of these factors give HSS Engineering® the ability to deliver a full turnkey project in the same high standard every time - anywhere in the world. Nevertheless, we also cooperate with local expert companies to deliver the best solutions.

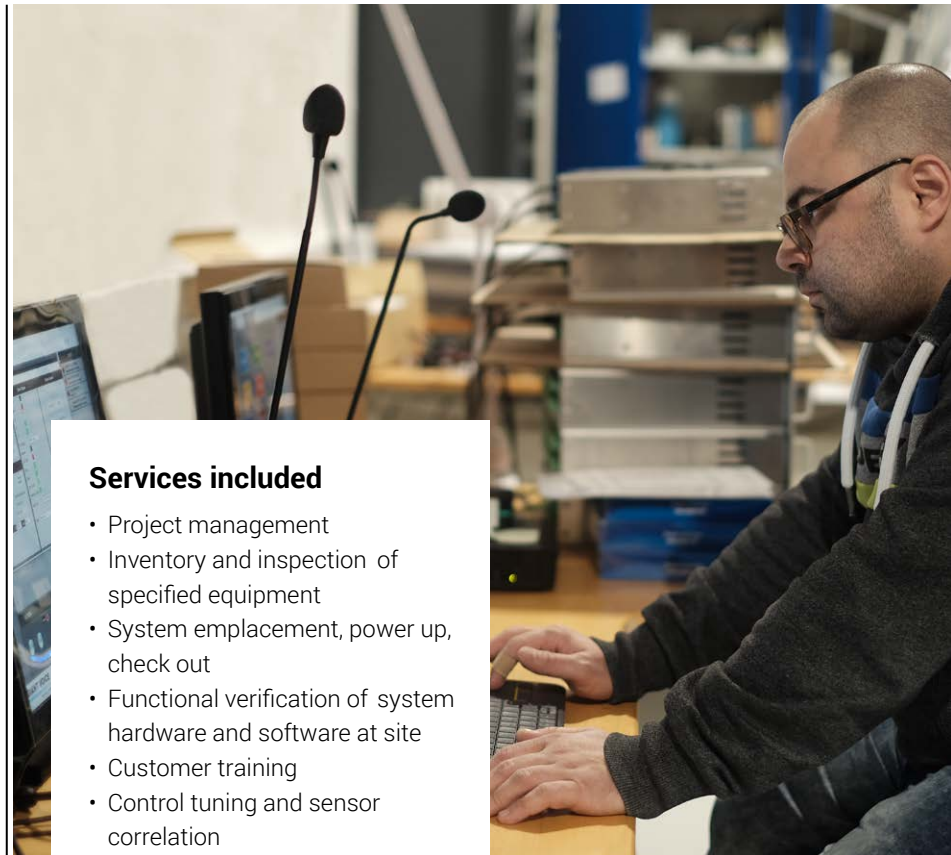

Services included

- Project management
- Inventory and inspection of specified equipment
- System emplacement, power up, check out
- Functional verification of system hardware and software at site
- Customer training
- Control tuning and sensor correlation
- Performance verification and documentation

Benefits

- Streamlined process
- Smoother installations
- Improved quality
- Faster start up at lower cost
- Improved efficiency
- Optimized system performance
- Significantly better end result



Alerting and notification solutions step by step.

WE TRANSFER OUR KNOWLEDGE

HSS Engineering® offers private courses for customers and business representatives all around the globe, who are looking for a detailed explanation of our delivered system, technological solutions and services.



We educate our staff thoroughly.

At HSS Engineering® we are passionate learning facilitators and we target our training courses at the level of the participants.

Some of the course topics include:

- Company overview
- System concept overview
- Communication
- Giant Voice® – Emergency management system training
- Discussing different system scenarios
- SPL standards
- System maintenance
- System troubleshooting

We have custom courses for all customers based on their focus areas. Our training courses are held at our headquarters in Denmark as well as on site, depending of our customers' needs.

Within the HSS Engineering® training, we use exercises and activities in which our participants can get practically involved. As a result, the participants gain knowledge of how the system operates.

We have divided our training classes into 4 levels

- Operators training
- Basic service and maintenance
- Advanced service and maintenance
- System administrator/ administration

All classes are complemented with an official HSS Engineering® training class certificate stating the level and time of training.



Alerting and notification solutions step by step.

WE OFFER

SUPPORT 24-7

Our support and maintenance program can provide both reactive (emergency support) services and proactive (preventative maintenance) services. We currently run service programs ranging from on-call service for hardware repair to full-time deployed engineers in war zones.

Warning systems supplied by HSS Engineering® have a two-year warranty period and require very low maintenance. However, even after the warranty period has expired, ongoing support and technical assistance is available. HSS Engineering®'s support and maintenance program can provide both reactive (emergency support) services and proactive (planned preventative maintenance) services.



With an on-site support and maintenance program you get the combination of experience, technical knowledge and on-site support that ensures that your system can perform at any time. This program features a single point of contact for quick and reliable assistance, and HSS Engineering®'s dedicated personnel offers a professional service to its valued customers all over the world. All terms for our support and maintenance program can be set according to the specific customer needs. As such we currently run service programs ranging from on-call service over hardware repair to full-time deployed engineers in war zone.

Alerting and notification solutions step by step.

KEEP YOUR SYSTEM RUNNING

Planned preventative maintenance

A preventative maintenance contract with HSS Engineering® provides periodic checks and alignment to keep the system operating at published specification levels and helps prevent failures.

During our preventative maintenance, in addition to the standard maintenance, we also examine all consumable and possible failure parts of the system and report on their condition. Rectification can then be made avoiding a potentially costly and disruptive system failure.

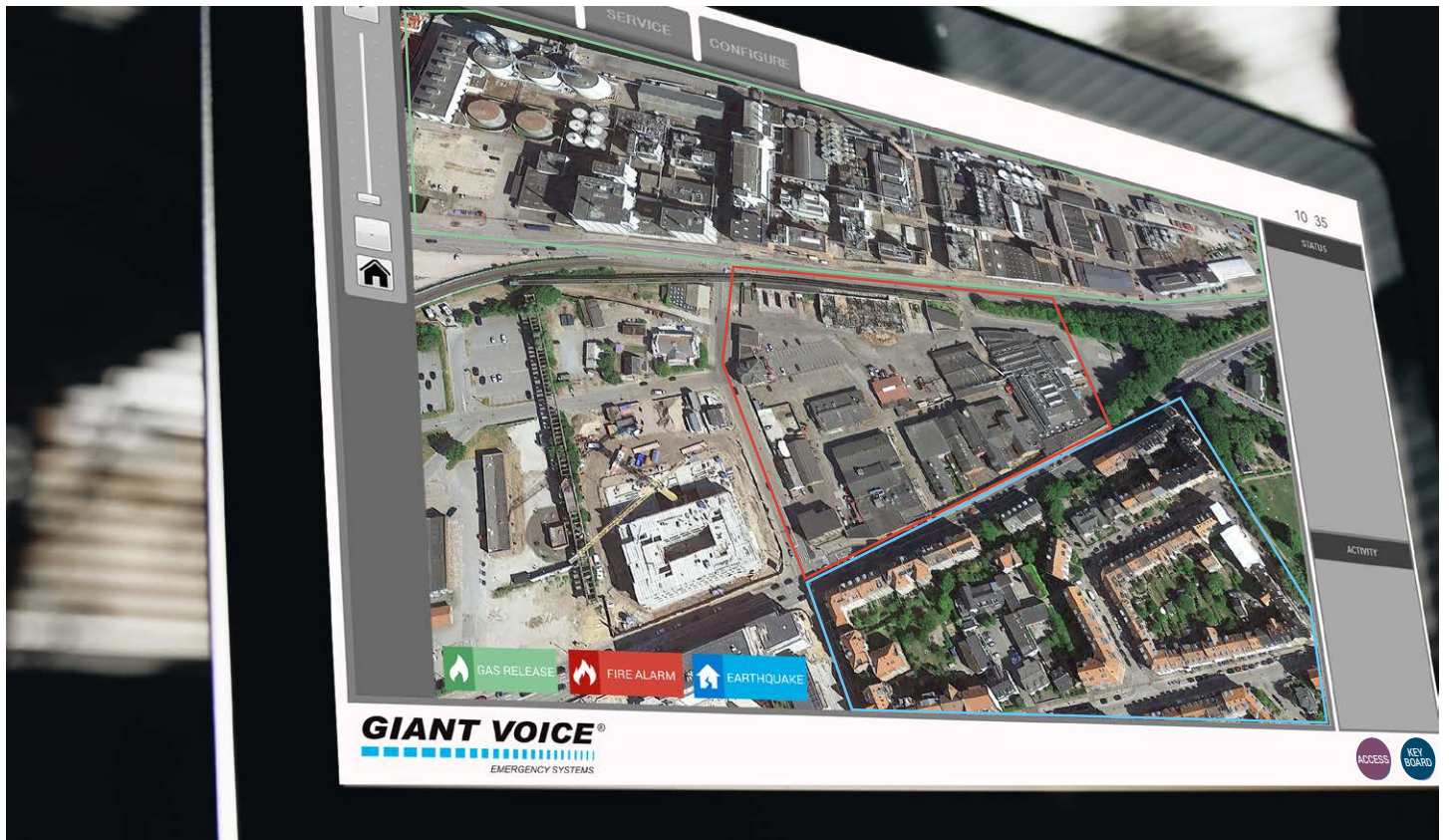

Reactive service

With a reactive service contract with HSS Engineering®, we take responsibility for the full repair by authorized HSS Engineering® personnel if a piece of equipment should fail.

In a standard reactive service contract, you send the failed equipment to us for repair or replacement and we will return it to you within the agreed maximum time scale. The reactive service contract can also contain a 24-hour-hotline e-mail and telephone service for quick and reliable assistance.

On-site service and maintenance

When the preventative and reactive maintenance services are not sufficient for your warning system solution, we also provide an on-site support and maintenance contract.

The on-site service and maintenance contract is tailored specifically to your needs and requirements. We offer every level of service from an on-call service to a full time deployed engineer 24 hours a day, 7 days a week and 365 days a year.



- Headquarters
- Sales Departments
- Regional Sales

FOR FURTHER INFORMATION
PLEASE CONTACT OUR SPECIALISTS
FROM YOUR REGION

ASIA

Jamal Kaddoura / Business Development Manager
P +45 8736 2486 / jmk@hss.dk

AFRICA

Jamil Mahmoud / Business Development Manager
P +45 8736 2489 / jkd@hss.dk

USA / OCEANIA

James Sturzenegger / Business Development Manager
P +45 8736 2493 / P +1 404-382-0025 / jms@hss.dk

LATIN AMERICA

Enrique Asanza / Business Development Manager
P +45 8736 2440 / P +45 5267 9486 (+ WhatsApp) / ena@hss.dk

EUROPE / DEFENSE

Lene H. Sorensen / Director
P +45 8736 2478 / lhs@hss.dk

MIDDLE EAST

Salah Albattah / Regional Sales Manager
P +966 550 510 241 / P +962 795 045 234 / sab@hss.dk

INDIA / SAARC

Harish Sandal / Senior Technical Consultant & Regional Sales Manager
P +91 99100 34003 / hsa@hss.dk

SPAIN / PORTUGAL / LATIN AMERICA

David Montero / Senior Technical Consultant & Regional Sales Manager
P +34 640 795 251 (+ WhatsApp) / dms@hss.dk

COLOMBIA

Nick Castro / Sales Manager
P +57 316 689 5949 / nkc@hss.dk

ORBCOMM®

CONNECTING THE
WORLD'S ASSETS



ST 9100

Hardware Guide

T413, Version 03
Apr 2021

© ORBCOMM®

CONTACT AND LEGAL INFORMATION

Visit ORBCOMM Online

www.ORBCOMM.com

Contact Support

partner-support@orbcomm.com

+1.613.836.2222

<https://partner-support.orbcomm.com>

Export Control Statement

The contents of this document, in whole or in part, shall not be exported from the United States, which export shall include, but not be limited to, transmittal to any non-U.S. citizen wherever said person is located, except in accordance with all United States laws and regulations relating to exports and to all administrative acts of the U.S. Government pursuant to such laws and regulations. Diversion, re-export or transshipment of the contents of this document, in whole or in part, contrary to U.S. law is also strictly prohibited.

Trademark Notice

The ORBCOMM name and the ORBCOMM logo are registered trademarks owned by ORBCOMM LLC or its affiliated companies.

The u-blox name and logo are registered trademarks of u-blox Holding AG.

The Bluetooth® wordmark and logos are registered trademarks owned by the Bluetooth SIG, Inc.

INMARSAT, the Inmarsat logo and IsatData Pro are trademarks of Inmarsat used under license by ORBCOMM. Inmarsat is not responsible for the operation and regulatory compliance of the products and services referred to in this document that connect to the Inmarsat system.

Other trademarks, trade names, and logos are those of their respective owners.



TABLE OF CONTENTS

Contact and Legal Information	2
Contact Support	2
TABLE OF CONTENTS	3
List of Figures	5
List of Tables	5
Preface	6
Purpose	6
Notation	6
Reference	6
Battery Safety Warnings	6
1 Product Overview	8
1.1 Overview of the Messaging System	9
1.2 Terminal	10
1.3 Transceiver Components	10
1.3.1 Transceiver Unit	10
1.3.2 Satellite Antenna	11
1.3.3 Cellular Antenna	12
1.3.4 Terminal Shroud	13
1.3.5 ST 9100 Cables and Connectors	13
2 Specifications	14
2.1 Temperature	14
2.1.1 Internal Backup Battery Temperature	14
2.2 Electrical	14
2.2.1 Input Range	14
2.2.2 Power Consumption	14
2.2.3 Load Dump Protection	15
2.2.4 Inrush Currents	15
2.2.5 Reverse Voltage Input	15
2.2.6 SIM Cards	15
2.3 Connectors	16
2.3.1 Connector Pin Assignment	16
2.4 I/O Interface	17
2.4.1 Standard General Purpose I/Os	17
2.4.1.1 Digital Input	18
2.4.1.2 Digital Output	19
2.4.1.3 Analog Input	20



2.4.2 Dedicated Outputs	20
2.4.3 Multi-purpose Ports	21
2.4.3.1 Input Only Ports	21
2.4.3.2 Analog Inputs (0-5 V)	22
2.4.3.3 Inputs 4-20 mA	22
2.5 Serial Interfaces	23
2.5.1 CAN Bus	23
2.5.2 RS-485/J1708	24
2.5.3 RS-232 (Console and Auxiliary)	24
2.5.4 1-Wire	24
2.6 RF Specifications	25
2.6.1 Satellite (Standard) Antenna	25
2.6.2 Satellite (Low Elevation) Antenna	25
2.6.3 Cellular Antenna	25
2.6.3.1 Cellular Antenna Electrical	26
2.7 Satellite Transmitting Power	26
2.8 GNSS Module	26
2.9 Internal Backup Battery	26
2.10 Memory	27
2.11 Environmental	27
2.12 Sensors	28
2.12.1 Temperature Sensor	28
2.12.2 Accelerometer	28
2.13 Cellular Module - LTE	28
2.13.1 Transceivers Operating in the Americas	28
2.13.2 Transceivers Operating Outside of the Americas	29
2.14 LED	30
2.15 Mechanical	31
2.15.1 ST 9100	31
2.15.2 Cellular Antenna	32
2.15.3 Satellite Antenna	33
2.15.3.1 Standard Antenna	33
2.15.3.2 Low Elevation Antenna	34
2.15.3.3 Terminal Shroud	34
3 Compliance	36
APPENDIX A Development Cable	38



LIST OF FIGURES

Figure 1: ST 9100 Satellite-Cellular Transceiver	8
Figure 2: System Architecture	9
Figure 3: Connector Position	11
Figure 4: SIM Access Door	11
Figure 5: Reset Button	11
Figure 6: Standard Satellite Antenna	12
Figure 7: Low Elevation Satellite Antenna	12
Figure 8: Cellular Antenna	13
Figure 9: Terminal Shroud	13
Figure 10: Transceiver View of Connector	16
Figure 11: Digital Input	18
Figure 12: Digital Output	19
Figure 13: Analog Input	20
Figure 14: Open Drain Outputs	21
Figure 15: Dedicated Inputs	22
Figure 16: LED Location	30
Figure 17: ST 9100 Top View Dimensions	31
Figure 18: ST 9100 Side Connector View Dimensions	32
Figure 19: Satellite Antenna (standard and low elevation) - Bottom View (mm)	33
Figure 20: Standard Antenna Height Dimensions (mm)	33
Figure 21: Low Elevation Antenna Height Dimensions (mm)	34
Figure 22: Terminal Shroud Dimensions	35
Figure 23: Development Cable	38

LIST OF TABLES

Table 1: Transceiver with Internal Backup Battery Temperature Specifications	14
Table 2: Transceiver Input Currents	14
Table 3: Electrical Pin Assignment	16
Table 4: Multi-GNSS Specifications	26
Table 5: Internal Backup Battery	27
Table 6: LED Operation	30
Table 7: Development Cable Connectors	39

PREFACE

Purpose

This document is as an overview of the hardware characteristics and specifications for the ST 9100.

Notation

A terminal consists of a transceiver unit plus antennas.

Hardware components and hardware labels in this document might not be exactly as shown and are subject to change without notice.

CAUTION: This safety symbol warns of possible hazards to personnel, equipment, or both. It includes hazards that will or can cause personal injury, property damage, or death if the hazard is not avoided.

Note: A note indicates information with no potential hazard. A note indicates points of interest or provides supplementary information about a feature or task.

Numbered lists indicate a series of steps required to complete a task or function.

Bulleted lists highlight information where order or sequence is not crucial.

Reference

The content of the following documents might be useful in conjunction with this guide. These documents are available from the downloads section of the partner support website or from the ORBCOMM Developer Toolkit (ODT), which is also available from the website.

Document names and numbers are subject to change, or be discontinued, without notice. Always check the partner support website for the most current version of these documents.

[N210]	IsatData Pro Gateway Web Service 2 User Guide
[N206]	MTWS Cellular Protocol
[T404]	LSF Developer Guide (FW v4.x)
[T405]	IsatData Pro Service API Ref (FW v4.x)
[T414]	ST 9100 Installation Guide

Battery Safety Warnings

CAUTION: Do not short circuit or expose the battery to temperatures above the maximum rated temperature.

CAUTION: Always follow local disposal guidelines to properly dispose of the Lithium-ion battery and the device.

CAUTION: Store in a cool, well ventilated area. Elevated temperatures will result in shortened battery life.

CAUTION: DO NOT replace the battery. Changing the battery without ORBCOMM's permission could violate regulatory conformity.



CAUTION: DO NOT throw the internal battery or the device into fire.



1 PRODUCT OVERVIEW

The ST 9100 is a flexible, robust, and programmable dual mode satellite-cellular terminal. It is ideal for remotely monitoring and controlling fixed and portable assets in industries as diverse as transportation, oil and gas, utilities, maritime and more. The versatile, environmentally sealed ST 9100 is ideal for rugged environments in the world's most remote areas.

The ST 9100 (Figure 1) is a satellite-cellular terminal. Features include the following:

- An IsatData Pro satellite-cellular transceiver for communicating with the network
 - Part number ST9100-D01 for use in the Americas
 - Part number ST9100-C01 for use outside of the Americas
- An integral multi-GNSS subsystem
- Four (4) general purpose I/Os
- Two (2) dedicated open drain outputs
- Four (4) inputs (digital or 0-5 V analog of which the first two can be configured as 4-20 mA)
- Two (2) RS-232 ports
- One (1) RS-485 port
- Two (2) CAN Bus ports
- One (1) 1-Wire interface
- 3-Axis 16-bit accelerometer
- Multiple SIM support
- Cellular module
- Bluetooth connectivity
- Internal backup battery
- Satellite antenna (p/n ST901065-APA standard antenna, ST901066-APA low elevation antenna)
- Cellular antenna - LTE/3G/2G fallback (p/n ST101066-001)
- Terminal shroud (optional- p/n ST101014-001)

Figure 1: ST 9100 Satellite-Cellular Transceiver



The transceiver's built-in programmability allows it to work as a standalone data-messaging transceiver, with built-in I/O data collection and processing capabilities. Feature-rich software tools make programming easy and shorten the design and testing time. The transceiver can also be configured with terminal apps. Terminal apps are configurable device-level applications that include specific feature sets that are implemented by ORBCOMM. Contact Customer Support or your Account Manager for further details.

1.1 Overview of the Messaging System

The IsatData Pro satellite messaging system is designed to support the management of mobile or fixed assets located around the world. An asset fitted with one of ORBCOMM's satellite based mobile terminals can have their status and locations monitored and send large messages.

The network provides the following key features and benefits:

- Polling of terminal status and location
- Scheduled reporting of terminal status and location
- Transmission of text messages to and from a serial port on the transceiver
- Two-way communication for messaging to and from the asset for near real-time control
- Up to 6,399 bytes from-mobile messages
- Up to 10,000 bytes to-mobile messages
- Default acknowledged messages
- Global service

Service is provided to end users by Solution Providers (SPs) who use the IsatData Pro network to offer particular applications and/or services to their clients. The SPs link their application services to the satellite terminals by connecting to the IsatData Pro gateway. This acts as the communications hub of the system, routing traffic to and from the terminals and the various service providers.

The terminal can be configured to route cellular messages through the same IsatData Pro Gateway that supplies satellite messages. This is shown as Option 1 in the System Diagram. Option 2 represents a terminal configured to route cellular messages directly to a customer or Solution Provider proprietary cell server. In this case the connection to ORBCOMM's IsatData Pro Gateway supplies satellite messages. Refer to [\[T404, N206, and N210\]](#) for more information about configuring the terminal's cellular messaging transport.

Figure 2: System Architecture

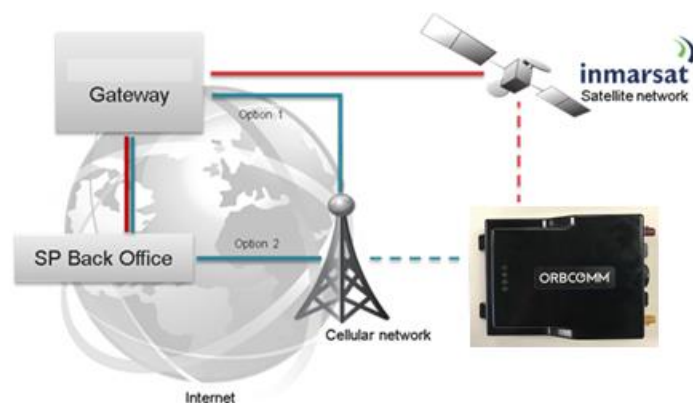

The satellite-cellular terminal is based on Lua software and is supported by a suite of IsatData Pro tools, enabling SPs a programmable platform they can tailor to their specific applications.

1.2 Terminal

Note: Hardware components may not be exactly as shown in this document. A terminal consists of a transceiver unit plus antennas.

Transceivers with a standard antenna operate on the IsatData Pro network at an elevation angle of 20° to 90° and -5° to 90° for transceivers with low elevation antennas. The transceivers are self-contained, compact, and provide low power consumption.

A cellular module is available to operate over the cellular network

The transceiver's built-in programmability allows it to work as a stand-alone with built-in I/O data collection and processing capabilities. Terminals are suitable for the AVL market.

Feature-rich software tools make application design easy and shorten the design and testing time. ORBCOMM also provides consulting services to SPs to help program the transceiver and get customer applications running quickly.

1.3 Transceiver Components

CAUTION: Do not rely solely on the terminal for emergency (SOS) calls.

In addition to the features mentioned earlier, the transceiver has the following benefits:

- Designed to be used as a standalone or incorporated into an SP solution
- Built-in dual-GNSS receiver to calculate position, speed, and heading
- Quick and easy installation reduces labor time and costs
- Installed firmware
- Flexible custom application design (Lua Services Framework)
- Wide operational temperature range
- Satellite plus cellular modem integration
- Discrete I/O ports to interface with a wide range of after-market accessories
- Rugged construction

1.3.1 Transceiver Unit

Each transceiver is a self-contained unit, including a satellite/cellular modem, a multi-GNSS module, programmable microcontroller, and multiple discrete and analog I/Os (input/output) capable of monitoring and controlling external sensors and devices. Ideal for mobile applications, it is also suitable for fixed installations.

Arranging the transceiver unit's connectors (Figure 3) at one end of the unit simplifies installation. Sturdy flanges on the side make mounting quick and easy.

Figure 3: Connector Position



An anti-tamper SIM door on the back side of the transceiver (Figure 4) provides easy access to the SIM card holder and reset button.

Figure 4: SIM Access Door



Figure 5: Reset Button



1.3.2 Satellite Antenna

CAUTION: Use only color-matching antennas.

The satellite-cellular transceiver's satellite antenna is waterproof and designed to operate in extreme environments. It has four mounting flanges for installation.

The satellite antenna connects to the transceiver using a 5 m (16 ft.) cable terminated with a curry yellow colored FAKRA RF connector.

The satellite-cellular transceiver is available with either the standard satellite antenna (Figure 6) or the low elevation satellite antenna (Figure 7).

Figure 6: Standard Satellite Antenna



Figure 7: Low Elevation Satellite Antenna



1.3.3 Cellular Antenna

CAUTION: Use only color-matching antennas.

The ST 9100 cellular antenna is an LTE antenna with a burgundy colored FAKRA connector.

Figure 8: Cellular Antenna



1.3.4 Terminal Shroud

Use the optional terminal shroud if mounting the transceiver outdoors.

Figure 9: Terminal Shroud



1.3.5 ST 9100 Cables and Connectors

The following are available for the ST 9100:

- A 5-meter blunt cut cable (p/n ST101062-002). Refer to [\[T414\]](#) for details.
- An IP67 Field Installable Connector (p/n ST101096). Refer to [\[T414\]](#) for details.
- A development cable (p/n ST101084-001). Refer to [APPENDIX A](#) for details.

CAUTION: An external 5 A slow blow fuse must be added in series with the external voltage wire ([Table 3](#)).

2 SPECIFICATIONS

2.1 Temperature

Parameter	Value
Operating Temperature Range	-20°C to +80°C (-4°F to +176°F)
Storage Temperature Range	-20°C to +35°C (-4°F to +95°F)

2.1.1 Internal Backup Battery Temperature

Table 1 defines the internal backup battery's temperature specifications.

Table 1: Transceiver with Internal Backup Battery Temperature Specifications

Parameter	Value
Charge Temperature Range	0°C to +45°C (32°F to +113°F)
Discharge Temperature Range	-20°C to +75°C (-4°F to +167°F)
Storage Range	
≤ 1 month	-20°C to +45°C (-4°F to +113°F)
≤ 3 months	-20°C to +35°C (-4°F to +95°F)
≤ 1 year	0°C to +30°C (32°F to +86°F)
Ideal for long-term storage	10°C to +25°C (60±25% R.H.), (50°F to +77°F)

2.2 Electrical

2.2.1 Input Range

CAUTION: An external 5 A slow blow fuse must be added in series with the external voltage wire (Table 3).

Parameter	Value
Power Supply Voltage	9 to 32 V DC

2.2.2 Power Consumption

Typical values with a transceiver input voltage of 12 VDC.

Table 2: Transceiver Input Currents

Mode of Operation	Condition	25°C (77°F)	-40°C (-40°F)	85°C (185°F)	Unit
Sleep	Externally powered	511	322	750	μA
Charger	ON	400	N/A	N/A	mA
SatCom Tx	Burst current	733.87	720.77	728.13	mA

Mode of Operation	Condition	25°C (77°F)	-40°C (-40°F)	85°C (185°F)	Unit
SatCom Rx	Burst current for Rx frequency. 1540045000 1000 2 (C/No=42dBHz)	76.70	25.77	80.13	mA
GPS	Cold fix current during uBlox on command	32.60	38.37	36.59	mA
TOBY Rx (Idle)	measure Rx level in 129 channels for 1000 ms intervals	91.52	101.36	102.3	mA
	measure Rx level in LTE FDD5 for 1000 ms	88.97	92.31	104	mA
	measure Rx level in LTE FDD 12 for 1000 ms	89.17	91.10	156.92	mA
TOBY Tx max	2G-850 TX in channel=189, PCL=0 (max power), Seq=5, Mod=1(GMSK), Interval=5000 ms	403.99	375.03	473.8	mA
	2G-900 TX in channel=37, PCL=0 (max power), Seq=5, Mod=1(GMSK), Interval=5000 ms	777.52	614.95	900	mA
	2G-1900 TX in channel=698, PCL=0 (max power), Seq=5, Mod=1(GMSK), Interval=5000 ms	504.42	510.73	525.17	mA
	4G FDD band 5, 850MHz, TX in channel=120525, power=24 dBm, Internal=5000 ms	224.88	202.20	236.68	mA
	4G FDD band 2, 1900MHz, TX in channel=118900, power=24 dBm, Internal=5000 ms	270.94	288.16	282.63	mA

2.2.3 Load Dump Protection

Active load dump protection is provided on the power pins. The cut-off is >34 V and automatic reset of the load dump occurs when the input voltage is <34 V.

2.2.4 Inrush Currents

Typical inrush currents: 12 volts and 25°C (77°F).

Quantity	Value
Peak in-rush current	4.12 A
In-rush pulse duration	138 μS

2.2.5 Reverse Voltage Input

Parameter	Voltage
Reverse Polarity Protection	-40 V DC (maximum)

2.2.6 SIM Cards

The transceiver offers two embedded (not field replaceable) and one removable 3FF (micro SIM) SIM card. The specifications for the SIM cards are the same.

Parameter	Value
SIM Voltage	1.8 V or 3 V standard SIM cards
Card Detection	Switch connected to cellular module

2.3 Connectors

Transceiver 24 position mating connector	Chogori Technology Company
Satellite Antenna	IMS Connector Systems 3400.SMBA.2K10.089 (RG58/LMR-195 sized cable) FAKRA - K-curry yellow
Cellular Antenna	IMS Connector Systems 3400.SMBA.2D10.029 9RG174 sized cable) FAKRA - D-bordeaux

2.3.1 Connector Pin Assignment

Table 3 maps to the layout shown in Figure 10.

Figure 10: Transceiver View of Connector

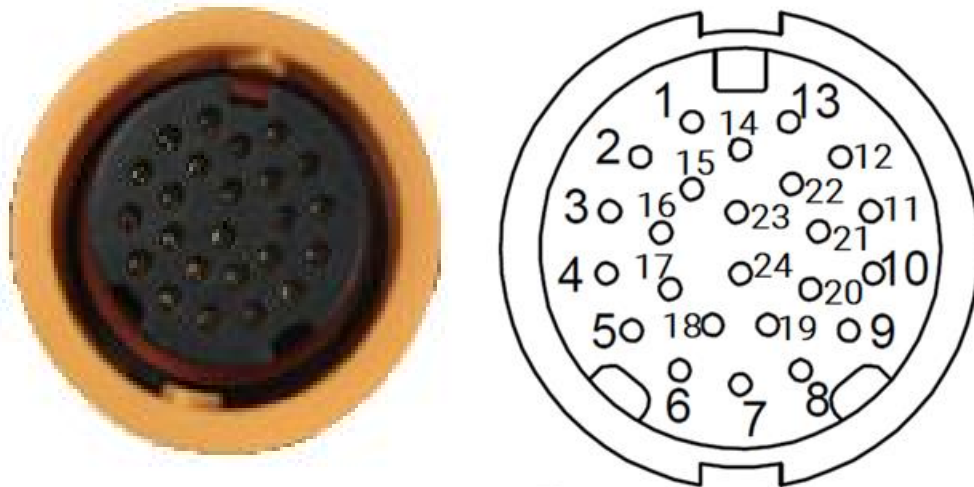

Table 3: Electrical Pin Assignment

PIN	Function	Type	Description
1	RS485_A	I/O	Half duplex RS485 driver output or receiver input (complementary to RS485_B)
2	Digital_IN4 / 0-5 V_IN4	I	Digital input or 0-5 V analog input
3	Digital_IN3 / 0-5 V_IN3	I	Digital input or 0-5 V analog input
4	I/O_4	I/O	Multifunction GPIO, push-pull, analog input, current limited current sink or ignition load
5	I/O_2	I/O	Multifunction GPIO, push-pull, analog input or current sink
6	Ground	PWR	External supply ground return
7	External Voltage	PWR	External 9-32 VDC supply
8	Output_6	O	Open drain output

Parameter	Min.	Max.	Units
Current Loop			
Operating current range	4	20	mA
Load voltage at 4 mA	0.396	0.404	V
Load voltage at 20 mA	1.98	2.02	V
Load resistance	99	101	Ω
Loop voltage (supplied by users externally)	10	32	V
Maximum input high voltage	-	32	-
ESD			
TVS breakdown voltage	40	44.2	V
TVS clamp voltage	-	58.1	V

2.5 Serial Interfaces

Transceivers have the following interfaces:

- 2 x CAN Bus
- 1 x RS-485/J1708
- 2 x RS-232
- 1 x 1-Wire

2.5.1 CAN Bus

The transceiver provides two CAN Bus interfaces for sending and receiving frames.

The transceiver incorporates a controller area network interface with signaling rates up to 1 Mbps.

Note: You must provide a termination resistor externally to the transceiver.

Parameter	Min.	Typical	Max.	Units
Input Common Mode Voltage	-7	-	12	V
Differential Input Threshold	-6	-	6	V
Peak to Peak Output Common Mode Voltage	-	1	-	V
Differential Output Voltage (dominant)	1.2	-	3	V
Differential Output Voltage (recessive) No Load	-0.5	-	0.05	V
CANH or CANL	-36	-	36	V
ESD Protection				
Human Body Model ¹	-	±16	-	kV
Contact Discharge Model	-	±30	-	kV

¹All electrical interfaces operate normally after being subjected to 8 kV ESD contact discharge per IEC 60945 and IEC 61000-4-2 human body model, level 3.

PIN	Function	Type	Description
9	1Wire Com	PWR	1-WIRE return path
10	Console_RS232_TX	O	±15 kV ESD protected, RS-232 level (nominally ±5.5 V) transmitter outputs
11	AUX_RS232_RX	I	TTL/CMOS level receiver outputs
12	CAN1_H	I/O	High level CAN BUS line
13	CAN1_L	I/O	Low level CAN BUS line
14	CAN0_L	I/O	Low level CAN BUS line
15	RS485_B	I/O	Half duplex RS485 driver output or receiver input (complementary to RS485_A)
16	Digital/Analog_IN1 / 0-5 V_IN1 / P1_4-20 mA+	I	Digital input or 0-5 V analog input or 4-20 mA input
17	I/O_3	I/O	Multifunction GPIO, push-pull, analog input or current sink
18	I/O_1	I/O	Multifunction GPIO, push-pull, analog input or current sink
19	Output_5	O	Open drain output
20	1Wire_DATA	I/O	Input/output driver for 1-Wire Line
21	Console_RS232_RX	I	TTL/CMOS level receiver outputs
22	AUX_RS232_TX	O	±15 kV ESD protected, RS-232 level (nominally ±5.5 V) transmitter outputs
23	CAN0_H	I/O	High level CAN BUS line
24	Digital_IN2 / 0-5 V_IN2 / P2_4-20 mA+	I	Digital input or 0-5 V analog input or 4-20 mA input

2.4 I/O Interface

2.4.1 Standard General Purpose I/Os

The transceiver supports four (4) configurable general purpose I/Os (GPIO I/O_1 to I/O_4):

- Digital input with weak (1 MΩ) pull-down
- Digital input with 20-50 K pull-down
- Digital input with 20-50 K pull-up
- Analog input
- Digital output – push-pull
- Digital output – open drain
- Disabled

On certain vehicles, I/O_1 can be used to monitor ignition. The voltage on the I/O pin may not drop low enough to present a logic zero to the host processor when the ignition is turned off. In such a case I/O_1 can be configured to switch in a 4 kOhm load to draw the voltage below the logic zero threshold level of the host processor ensuring a logic zero. The other I/O ports should not be used for ignition monitoring. Refer to section [2.4.1.1](#)

I/O_4 provides dedicated overcurrent/short circuit protection circuitry when operated in the open drain mode. The other I/Os do not have this circuitry therefore I/O_4 is recommended for applications requiring overcurrent/short circuit protection.

Simplified block diagrams of the I/O when configured as digital inputs, digital outputs, and analog inputs are shown in the figures below ([Figure 11](#), [Figure 12](#), and [Figure 13](#)).

The transceiver also supports two dedicated outputs (Output_5 and Output_6). More information on these outputs can be found in section 2.3.1.

2.4.1.1 Digital Input

Figure 11 shows a schematic of the I/O when configured as a digital input.

Figure 11: Digital Input

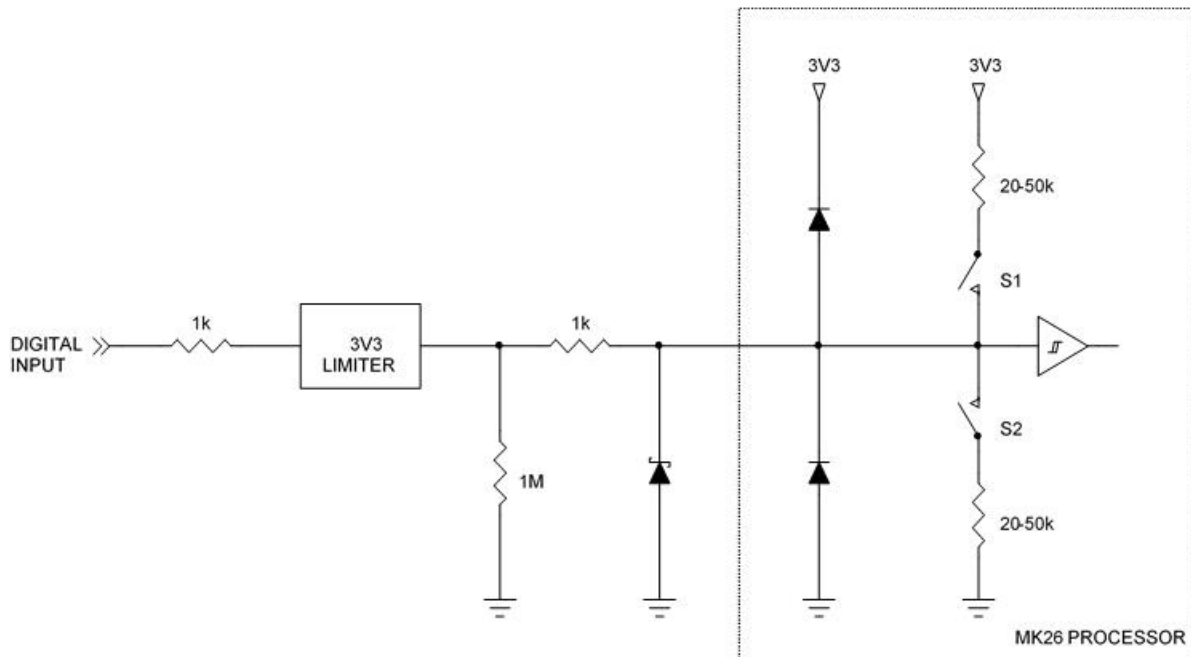

Input Type	S1	S2
With weak pull-down	Open	Open
With pull-down	Open	Closed
With pull-up	Closed	Open

The input specifications are provided in the table below.

Parameter	Min.	Typical	Max.	Units
Input low range	-10	-	1.16	V
Input high range	2.31	-	150	V
Input current with weak pull-down (weak 1 M Ω pull-down still in place); $V_{in} = 3.3$ V	-	4.5	-	μ A
Input source current with 50 k pull-up ($V_{in} = 0.0$ V)	-	75	-	μ A
Input sink current with 50 k pull-down ($V_{in} = 3.3$ to 150 V)	-	81	-	μ A
Input bandwidth	1	-	-	kHz

2.4.1.2 Digital Output

Figure 12 shows a schematic of the I/O when configured as a digital output.

Figure 12: Digital Output

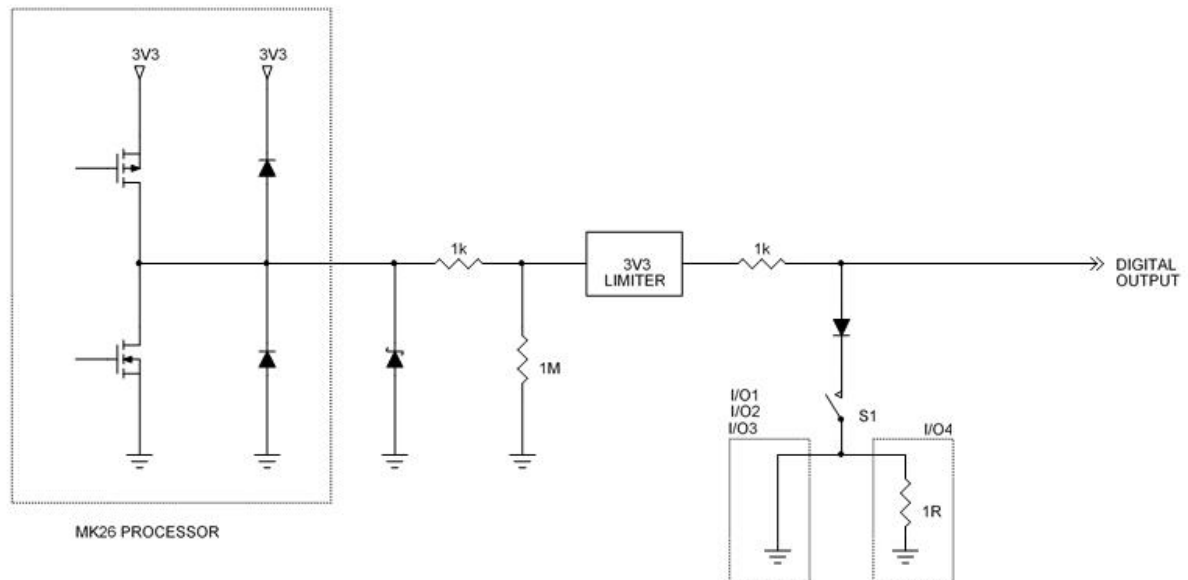

Push-pull	S1 = Open
Open drain	S1 = Closed (Low Impedance) S1 = Open (High Impedance)

2.4.1.2.1 Push-pull

In the push-pull configuration the output is driven directly from the microprocessor.

Parameter	Min.	Typical	Max.	Units
Output high voltage - open circuit	3.23	3.3	3.37	V
Output high voltage (sourcing 10 mA)	2.8	-	-	V
Output low voltage (sinking 10 mA)	-	-	0.5	V
Output bandwidth	100	-	-	Hz

2.4.1.2.2 Open Drain

Parameter	Min.	Typical	Max.	Units
Sink current (do not exceed)	-	-	250	mA
Output voltage (sinking 250 mA)				
I/O_1 to I/O_3	-	1.15	1.35	V
I/O_4	-	1.40	1.60	V
Absolute limits (high impedance)	-10	-	150	V
Output bandwidth	100	-	-	Hz

2.4.1.3 Analog Input

Figure 13 shows a schematic of the I/O when configured as an analog input.

Figure 13: Analog Input

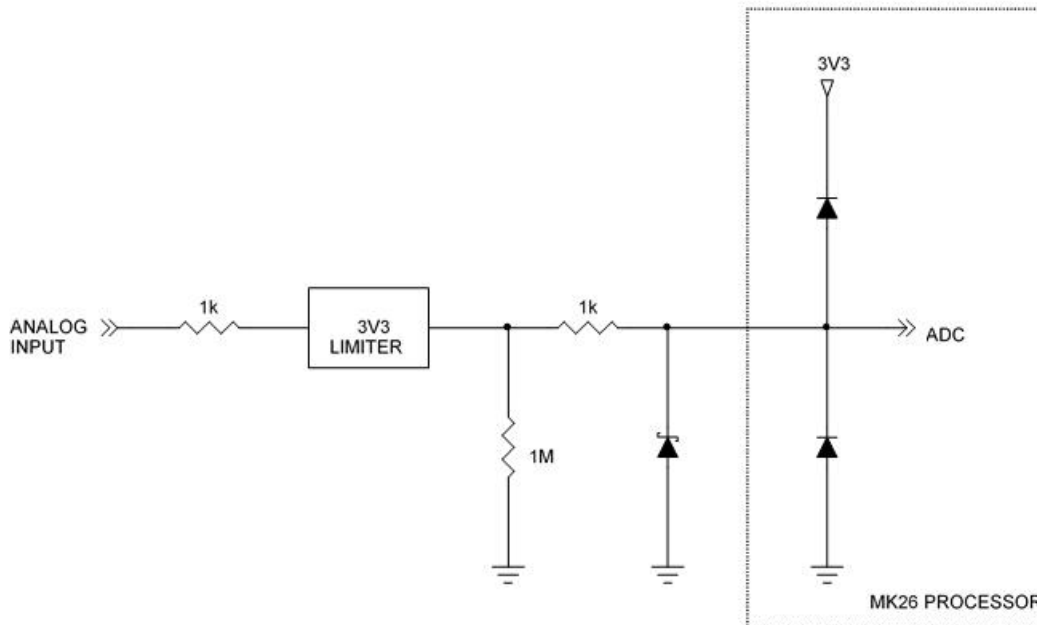

Parameter	Min.	Typical	Max.	Units
Input impedance	-	1	-	MΩ
Normal input measurement range	0	-	3.3	V
Resolution (12 bits)	-	0.8	-	mV
Proportional measurement error	-	-	3	%
INL error	-	-	2	LSB
Absolute limits	-10	-	150	V

2.4.2 Dedicated Outputs

The transceiver provides two open drain outputs (output_5 and output_6) that can be used to turn on various devices such as relays, lights or audible alarms. These outputs are capable of sinking current only. Both outputs are controlled from the host processor. The outputs are not protected against over current conditions and you must ensure that the maximum current capability of the internal switch is not exceeded. Both outputs include ESD protection. You must also ensure that the voltage applied to the output pin does not exceed the maximum value as shown in the table below.

Figure 14: Open Drain Outputs

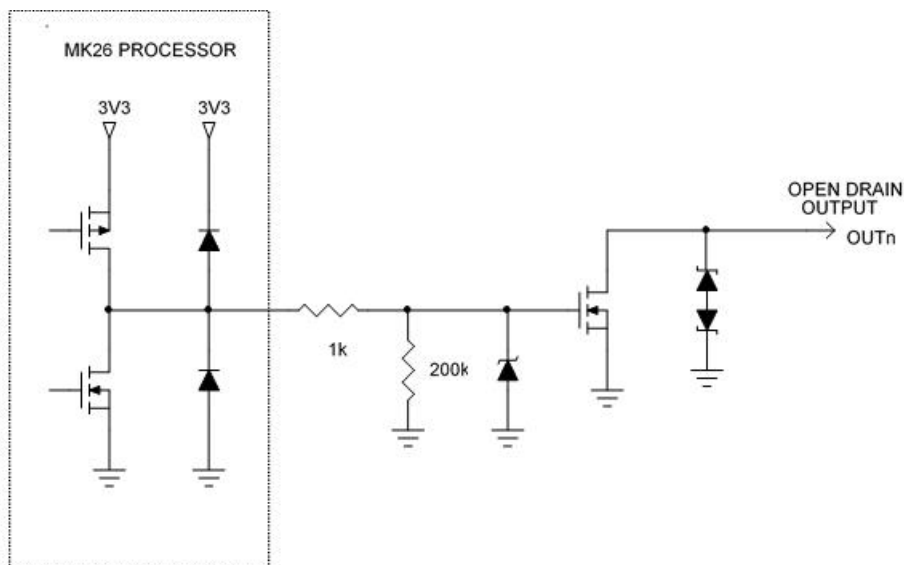

Parameter	Max.	Units
Sink Current	250	mA
Applied Voltage	40	V
Internal switch power dissipation	691	mW
Voltage output (sink current = 250 mA)	2.76 (minimum 48 mV)	V

2.4.3 Multi-purpose Ports

In addition to the standard I/Os, the transceiver provides the following multi-function ports.

- Four (4) digital input only ports.
- Four (4) 0-5 V analog input only ports.
- Two (2) 4-20 mA inputs.

Four pins on the interface connector are independently configured to provide the following combinations:

- Four (4) digital inputs or,
- Four (4) 0-5 V analog inputs or,
- Two (2) 4-20 mA inputs or,
- Two (2) digital inputs and two 0-5 V analog inputs or,
- Two (2) digital inputs and one 4-20 mA input or,
- Two (2) 0-5 V analog inputs and one 4-20mA input.

2.4.3.1 Input Only Ports

Four ports ([PINs 2, 3, 16, and 24](#)) can be configured as dedicated inputs. Each input is ESD protected by a 36 V transient voltage suppressor that clamps the input transient at 58 V. A 15 V Zener ensures the FET maximum gate voltage of 20 V is not exceeded.

Figure 15: Dedicated Inputs

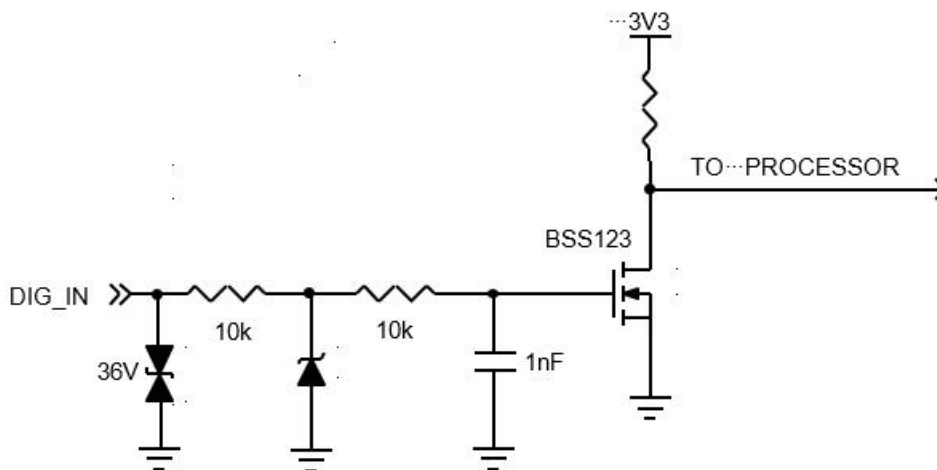

Parameter	Min.	Max.	Processor	Units
Digital Input				
Typical Input high voltage (Zener starts conducting at ± 14.49 V)	1.6	14	0	V
Maximum input high voltage	-	32	0	V
Input low voltage	0	1.4	3.3	V
Input frequency	1	10	-	Hz
ESD				
TVS breakdown voltage	40	44.2	-	V
TVS clamp voltage	-	58.1	-	V

2.4.3.2 Analog Inputs (0-5 V)

Four ports ([PINs 2, 3, 16, and 24](#)) can be configured as dedicated 0-5 V analog inputs. 0-5 V applied to the ports is converted to 0-3.3 V to be compatible with the ADC voltage range of the host processor.

Parameter	Min.	Max.	Units
Analog Input			
Input voltage range	0	5	V
Maximum input high voltage	-	32	V
ESD			
TVS breakdown voltage	40	44.2	V
TVS clamp voltage	-	58.1	V

2.4.3.3 Inputs 4-20 mA

The ST9100 can monitor two 4-20 mA sensors. Two ports ([PINs 16 and 24](#)) can be configured as two dedicated 4-20 mA receivers.

2.5.2 RS-485/J1708

The transceiver provides a half-duplex RS-485 or J1708 interface as an accessory bus and for SCADA interfacing with signaling rates up to 250 kbps.

Note: You must provide a termination resistor externally to the transceiver when required.

The electrical characteristics of the interface are:

Parameter	Min.	Typical	Max.	Units
Input Common Mode Voltage	-8	-	12.5	V
Differential Input Threshold	-200	-	200	mV
Output Common Mode Voltage	-	1.8	3	V
Differential Drive Output, 54 Ω load	1.5	2.3	-	V
ESD Protection				
Human Body Model	-	± 16	-	kV
Contact Discharge Model	-	± 30	-	kV

2.5.3 RS-232 (Console and Auxiliary)

The two RS-232 interfaces default to the following settings: 9600 bit/s, 1 start, 8 data, 1 stop bit, and no parity. The baud rate is configurable up to 115,200 bps.

The electrical characteristics of the interface are:

Parameter	Min.	Typical	Max.	Units
Rx Input Low Threshold for DTE Connected	-	-	-2.7	V
Rx Input High Threshold for DTE Connected	2.7	-	-	V
Rx Threshold for DTE Disconnected	-0.3	-	0.3	V
Serial Rx Input Low Threshold	0.6	-	-	V
Serial Rx Input High Threshold	-	-	2.4	V
Rx Input Voltage Range	-25	-	25	V
Serial Tx Low Output (3 k Ω load)	-	-	-3.7	V
Serial Tx High Output (3 k Ω load)	3.7	-	-	V
ESD Protection				
Human Body Model	-	± 15	-	kV
Contact Discharge Model	-	± 8	-	kV

2.5.4 1-Wire

The 1-Wire interface allows connection to downstream 1-Wire devices connected on a bus, or to a single button reader. Relative to any attached 1-Wire device, the transceiver behaves as the master. The 1-Wire driver supports 3 or 5 V devices on the bus.

At standard speed, the 1-Wire supports up to 39 devices over a 61-meter (200 feet) CAT5 cable. In overdrive, the usable expected distance is reduced to ≤ 15 meters (≤ 50 feet) with a maximum node count of 9.

The electrical characteristics of the interface are:

Parameter	Min.	Typical	Max.	Units
1-Wire Input High Voltage	3	-	-	V
1-Wire Input Low Voltage	-	-	1	V
1-Wire Output Low Voltage (IOL - 8 mA sink current)	-	-	0.2	V
1-Wire ESD Protection Diode and Resistors				
Avalanche Voltage	7.4	-	11.05	V
Trigger Voltage	-	10	11	V
Holding Voltage (IOL - 8 mA sink current)	5.5	-	-	V
Holding Current	11	-	-	mA
Continuous Diode Current	-	-	80	mA

2.6 RF Specifications

2.6.1 Satellite (Standard) Antenna

Parameter	Value
Maximum EIRP	7 dBW
Elevation Angle	20° to 90° degrees
Maximum transmit antenna gain	4.5 dBic
Rx Operating Frequency	1518-1559 MHz
Tx Operating Frequency	1626.5-1660.5 MHz, 1668-1675 MHz

2.6.2 Satellite (Low Elevation) Antenna

Parameter	Value
Maximum EIRP	5 dBW
Elevation Angle	-5° to 90° degrees
Maximum transmit antenna gain	2.5 dBic
Rx Operating Frequency	1518-1559 MHz
Tx Operating Frequency	1626.5-1660.5 MHz, 1668-1675 MHz

2.6.3 Cellular Antenna

Parameter	Value
Network Coverage	Global: Cat 4 LTE (B1, B3, B5, B7, B8, B28), UMTS (850, 900, 1900, 2100), Quad-band GSM Americas: Cat 1 LTE (B2, B4, B5, B12), UMTS (850, 900, 1900, 2100), Quad-band GSM
Frequency	700/824/960/1710/1880/2170/2600/2700 MHz
Impedance	50 Ω
VSWR	2.0:1
Gain	2.5 dB
Maximum EIRP	700-2700 MHz

2.6.3.1 Cellular Antenna Electrical

Frequency (MHz)	Return Loss (dB)	VSWR	Efficiency (%)	GAIN (dB)
700	-10.62	1.85	46.03	1.45
824	-22.27	1.16	36.48	0.6
960	-14.25	1.48	56.75	1.25
1710	-19.03	1.25	44.98	2.18
1880	-21.14	1.21	66.68	4.74
2170	-10.93	1.78	34.04	1.06
2600	-22.79	1.16	49.32	3.89
2700	-26.19	1.10	60.12	4.45

2.7 Satellite Transmitting Power

The maximum transmitting power (EIRP) for the IsatData Pro satellite is 7 dBW.

2.8 GNSS Module

The transceiver allows concurrent reception of up to three (3) GNSS channels.

The manufacturer's specifications are given in the table below.

Table 4: Multi-GNSS Specifications

Parameter	GPS	GLONASS	BeiDou	Galileo
Time to First Fix				
Cold Start	29 s	30 s	34 s	45 s
Warm Start	2s	2 s	3 s	7 s
Hot Start	1 s	1 s	1 s	1 s
Sensitivity				
Tracking	-162 dBm	-166 dBm	-160 dBm	-159 dBm
Hot Start	-157 dBm	-156 dBm	-155 dBm	-151 dBm
Cold Start	-148 dBm	-145 dBm	-143 dBm	-138 dBm
Accuracy				
Horizontal Position	2.5 m	4.0 m	3.0 m	4.0 m
Velocity	0.05 m/s			
Heading	0.3 degrees			

2.9 Internal Backup Battery

The internal backup battery provides autonomous battery charging to the transceiver and operates directly from the external supply over the 9-32 VDC input range. The internal backup battery contains a protection card to ensure that the pack does not get damaged due to a short circuit, over discharge or an over-charge condition.

If the battery voltage is below the minimum set voltage, the charger turns off.

Table 5: Internal Backup Battery

Parameter	Value
Battery Chemistry	Lithium Ion
Back-up Period	48 hours
Rated Capacity	2000 mAh
Charge (capacity) Retention	90% (after 28 days at 25 ±5°C (77 ±9°F))
Battery Cut-off	7 V
Nominal Pack Voltage	7.2 V (2 x cells in series)
Minimum Discharge Voltage	5 V
Charging Voltage	8.4 V
Peak Output Current	6 A

Refer to section 1.0.1 for internal backup battery temperature ranges.

2.10 Memory

Parameter	Value
PSRAM	8 MB
Flash	16 MB

2.11 Environmental

Parameter	Description
Vibration	The terminal meets all its specifications during exposure to random vehicular vibration levels per SAE J1455, section 4.10.4.2 figures 6, 7, and 8, and MIL-STD-810H, section 514.8, figure 514.8C-1.
Mechanical Shock	The terminal meets all its specifications after exposure to positive and negative saw tooth shock pulses with peaks of 20 G and durations of 11 ms as specified in MIL-STD-810H, section 516.8, Procedure I, section 2.3.2c.
Thermal Shock	The terminal meets all of its specifications after a thermal shock test as detailed in SAE J1455, section 4.1.3.2
Drop Test	The terminal meets all its specifications after a handling drop test as specified in SAE J1455, section 4.11.3.1.
ESD (Enclosure)	All electrical interfaces operate normally after being subjected to 6 kV ESD contact discharge per IEC 60945 and IEC 61000-4-2 human body model, level 3.
Altitude	The terminal meets all specifications after a nonoperating 12.2 km (7.5 miles) altitude test as detailed in SAE J1455, section 4.9.3, except with an ambient temperature of -40°C (-40°F).
Humidity	The terminal meets all its specifications during exposure to 90% relative humidity at +85°C (185°F), per the test methodology of SAE J1455, section 4.2.3 (3 x 8-hour humidity cycle per figure 4a)
Ingress Protection	IP67 – The terminal meets all of its specifications after immersion and dust tests as detailed in IEC 60529, sections 13.1, 13.4, 14.1, 14.2.7 and 14.3 (with and without optional terminal shroud)

2.12 Sensors

2.12.1 Temperature Sensor

Parameter	Value
Range	-40 to +85°C (-40 to +185°F)
Accuracy (typical)	±4°C (±7.2°F)

2.12.2 Accelerometer

The transceiver has a 3D 16-bit accelerometer to detect motion in any axis.

In low power applications, frequent GPS fixes can dominate the power budget. To reduce the power budget effects of GPS fixes, the accelerometer can be used to detect if motion has occurred.

The accelerometer thresholds to detect advanced features such as driver behavior monitoring vary depending on the environment. To avoid false detects, extensive testing is required to ensure that adequate acceleration magnitude thresholds and time durations are used.

Refer to [T405](#) for additional details.

Parameter	Condition	Min.	Typ.	Max.	Units
Resolution	-	-	16	-	bit
Acceleration Range	software selectable	-	+2	-	g
		-	+4	-	g
		-	+8	-	g
		-	+16	-	g
Output Data Rate (ODR)	selectable via digital interface	12.5	-	1600 ¹	Hz
Sensitivity	2 g	-	16384	-	LSB/g
	4 g	-	8192	-	LSB/g
	8 g	-	4096	-	LSB/g
	16 g	-	2048	-	LSB/g
Sensitivity Temperature Drift	3 V supply	-	±0.02	-	%/K
Zero-g Offset	Ta = 25°C (77°F)	-	±40	-	mg
Zero-g Offset Temperature Drift	3 V supply	-	±1	-	mg/K
Wake up Time	from low power or suspended modes	-	0.8	-	ms
Start up Time	power on reset	-	3.2	3.8	ms

2.13 Cellular Module - LTE

2.13.1 Transceivers Operating in the Americas

Transceivers (p/n ST9100-D01), operating in North or South America, have the following characteristics.

¹The software supports a maximum ODR of 400 Hz.

Type	u-blox Toby R200 series
LTE Module	LTE bands: 2, 4, 5, 12 UMTS bands: 850, 900, 1900, 2100 MHz GSM 850/900/1800/1900 MHz
Output Power	LTE power Class 3 (23dBm) UMTS/HSDPA/HSUPA power Class 3 (24dBm) GSM/GPRS Power Class: *Class 4 (33 dBm) for GSM/E-GSM band *Class 1 (30 dBm) for DCSPCS band EDGE(8-PSK) Power Class: *Class E2 (27 dBm) for GSM/E-GSM band *Class E2 (26 dBm) for DCS/PCS band
Input Power	Peak currents of 1.5 A typical, 1.9 A maximum. Module supply peak current consumption: peak of current consumption through the VCC pins during a GSM 1-slot Tx burst at maximum Tx power, with a matched antenna
Data Transfer	LTE Category 1: up to 10.3Mb/s DL, 5.2 Mb/s UL HSDPA category 8: up to 7.2 Mb/s DL, HSUPA category 6: up to 5.76 Mb/s UL GPRS multi-slot class 33, CS1-CS4, up to 107 kb/s DL, up to 85.6 kb/s UL EDGE multi-slot class 33, MCS1-MCS9, up to 296 kb/s DL, up to 236.8 kb/s UL
Antenna Detect	Output DC current pulse: 9 μ A typical Output DC current pulse time length: typical 330 μ s

2.13.2 Transceivers Operating Outside of the Americas

Transceivers (p/n ST9100-C01), operating outside of North or South America, have the following characteristics.

Type	u-blox Toby L280 series
LTE Module	LTE bands: 1, 3, 5, 7, 8, 28 UMTS bands: 850, 900, 1900, 2100 MHz GSM 850/900/1800/1900 MHz
Output Power	LTE power Class 3 (23dBm) UMTS/HSDPA/HSUPA power Class 3 (24dBm) GSM/GPRS Power Class: *Class 4 (33 dBm) for GSM/E-GSM band *Class 1 (30 dBm) for DCSPCS band EDGE(8-PSK) Power Class: *Class E2 (27 dBm) for GSM/E-GSM band *Class E2 (26 dBm) for DCS/PCS band
Input Power	Peak currents of 1.9 A typical, 2.5 A maximum. Module supply peak current consumption: peak of current consumption through the VCC pins during a GSM 1-slot Tx burst at maximum Tx power, with a matched antenna
Data Transfer	LTE Category 4: up to 150Mb/s DL, 50 Mb/s UL HSDPA category 24: up to 42 Mb/s DL, HSUPA category 6: up to 5.6 Mb/s UL GPRS multi-slot class 12, CS1-CS4, up to 85.6 kb/s DL/UL EDGE multi-slot class 12, MCS1-MCS9, up to 236.8 kb/s DL/UL

Antenna Detect	Output DC current pulse: 21 μ A typical Output DC current pulse time length: typical 3.6 ms
-----------------------	----------------------------------------------------------------------------------------------------





2.14 LED

The transceiver has four visible LEDs (2.14) to indicate status. For more detailed LED information, refer to [T404].

Figure 16: LED Location



Table 6: LED Operation

Icon	Function	Description	Color	LED ON	LED OFF
	Sensor	Indicates whether a central device (Bluetooth) is connected to the terminal or if the terminal is in fast advertising mode.	BLUE	Bluetooth Central Connected	Bluetooth Central Disconnected
	Cellular	Indicates cellular communications status. Note: This LED only functions if the cellular module is powered on. The operation of this LED is dependent on the type of cellular module being used in the device.	GREEN	Data 2G/3G /Registered LTE	No Service (no network or not registered)
	Satellite / Satcom	Indicates satellite communications status.	YELLOW	-Power ON /External Reset	-
	Power	Indicates that the transceiver has external power.	RED	External Power Present	External Power Absent

2.15 Mechanical

2.15.1 ST 9100

Parameter	Value
Mass	465 g (16 oz)
Enclosure Material	Lexan plastic

Figure 17: ST 9100 Top View Dimensions

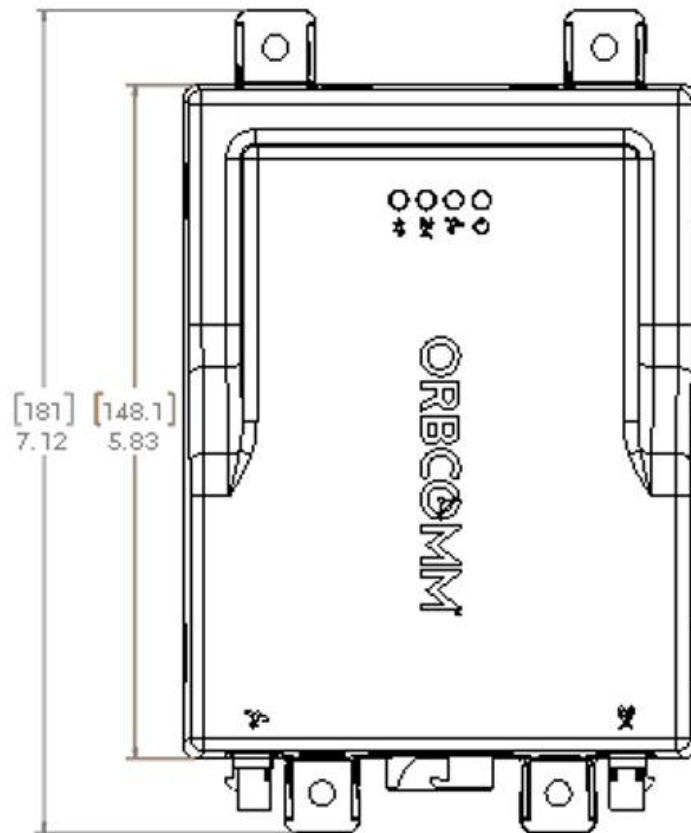
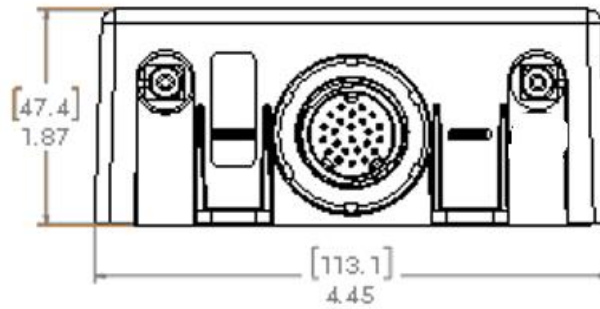

Figure 18: ST 9100 Side Connector View Dimensions



2.15.2 Cellular Antenna

Parameter	Value
Mass	55 g (2 oz.)
Dimensions	129.5 x 22.8 x 7 mm (5 in. x 0.9 x 0.27 in.)
Cable length	3 m (10 ft.)
Mounting	FAKRA straight plug connector
Operating Temperature	-40°C to 85°C (-40°F to 185°F)

2.15.3 Satellite Antenna

Figure 19: Satellite Antenna (standard and low elevation) - Bottom View (mm)

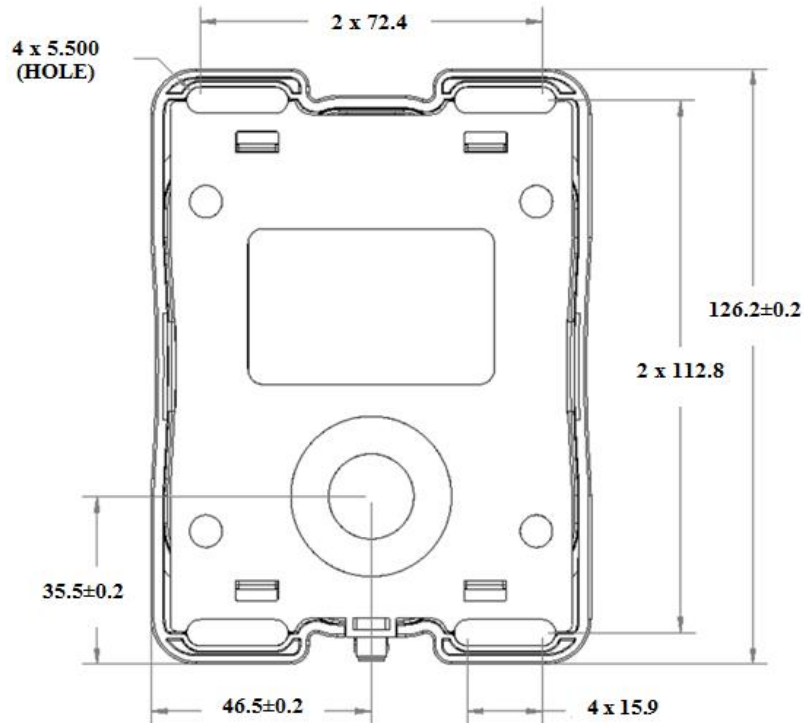

2.15.3.1 Standard Antenna

Parameter	Value
Mass	Side entry with 5 m (16 ft.) cable: 360 g (13 oz.)
Enclosure Material	Lexan EXL
Color Code	8T9D076 (white)
Sealing Gasket Material	Santoprene®

Figure 20: Standard Antenna Height Dimensions (mm)

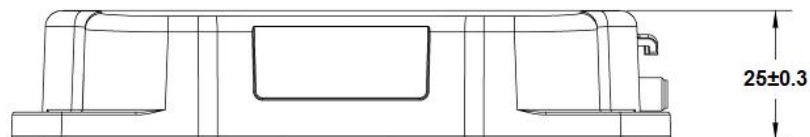

2.15.3.2 Low Elevation Antenna

Parameter	Value
Mass	Side entry with 5 m (16 ft.) cable: 365 g (13 oz.)
Enclosure Material	Lexan EXL
Color Code	8T9D076 (white)
Sealing Gasket Material	Santoprene®

Figure 21: Low Elevation Antenna Height Dimensions (mm)

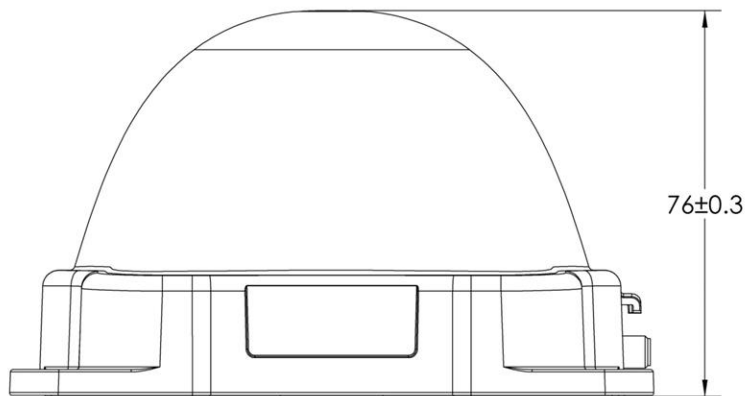

2.15.3.3 Terminal Shroud

Parameter	Value
Mass	150 g (2 oz.)
Enclosure Material	Lexan EXL
Color Code	8T9D076 (white)

Figure 22: Terminal Shroud Dimensions

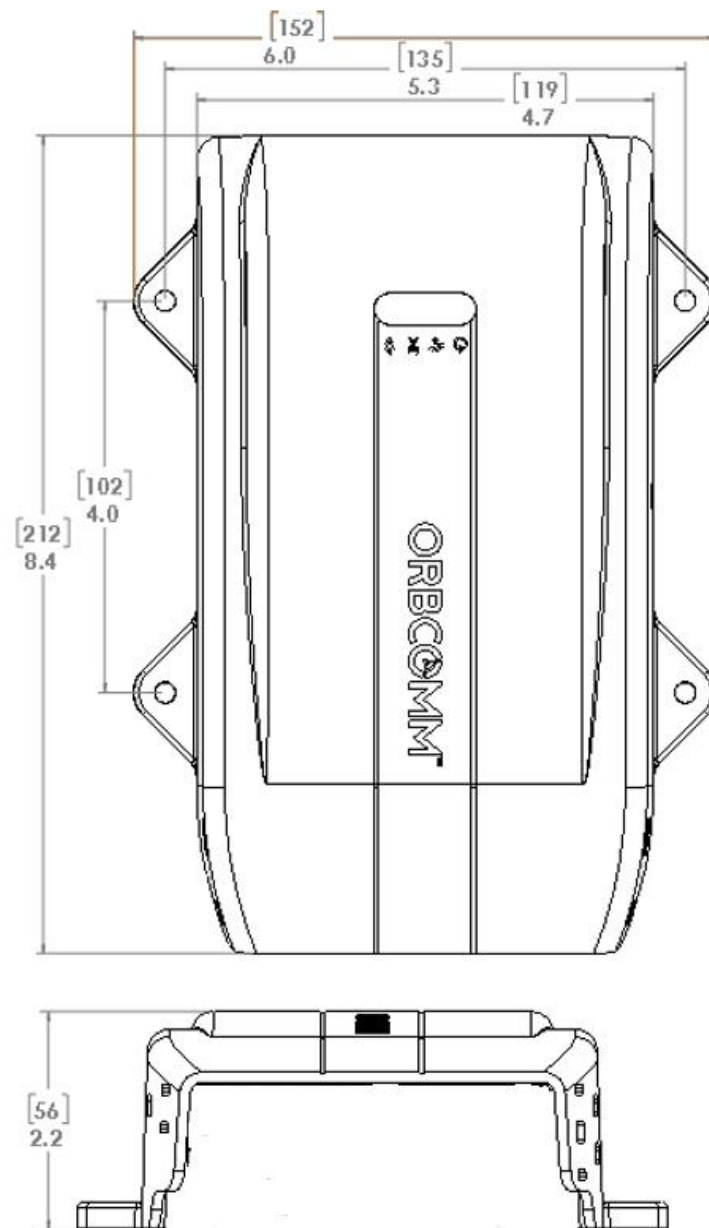

3 COMPLIANCE

Certifications for the following have been received, unless noted otherwise. Contact your Account Manger for updates.

Inmarsat Type Approval

Industry Canada

- IC certification is pending
- ICES-003
- RSS-170, Issue 2, Spectrum Management and Telecommunications Policy, Radio Standard
- RSS-102, radiation safety per Safety Code 6 (compliance shown by computation)
- IC ID: 11881A-ST9100; 11881A-UNNB30; 8595A-TOBYL280 OR 8595A-1EHM44NN

Anatel Homologation

FCC

- FCC certification is pending
- CFR 47 Part 25, CFR 47 Part 15
- CONTAINS FCC ID: XGS-ST9100; XGS-UNNB30; XPYTOBYL280 OR XPY1EHM44NN

CE RED 2014/53/EU

Ingress Protection

- Cellular antenna: IP65
- Satellite antenna: IP67
- Transceiver unit: IP67

RoHS

- Restriction of Hazardous Substances (RoHS) ¹

UN

- UN 38.3 Transportation Compliance

PTCRB

AMAC

- Certification is pending

¹European Union's (EU) Directive 2002/95/EEC "Restriction of Hazardous Substances" (RoHS) in Electronic and Electrical Equipment.

EU Declaration of Conformity

Hereby, ORBCOMM Inc. declares that the radio equipment types listed in this document comply with Directive 2014/53/EU.

The full text of the EU declaration of conformity is available from <http://www2.orbcomm.com/eudoc>.

WARNING:

- The minimum 20 cm (8 in.) separation distance from the device is required for RF exposure safety for all persons.
- Changes or modifications not expressly approved by the party responsible for compliance could void the user's authority to operate the equipment.
- This device contains licence-exempt transmitter(s)/receiver(s) that comply with Innovation, Science and Economic Development Canada's licence-exempt RSS(s). Operation is subject to the following two conditions: (1) This device may not cause interference.(2) This device must accept any interference, including interference that may cause undesired operation of the device.
 - L'émetteur/récepteur exempt de licence contenu dans le présent appareil est conforme aux CNR d'Innovation, Sciences et Développement économique Canada applicables aux appareils radio exempts de licence. L'exploitation est autorisée aux deux conditions suivantes :
 - 1) L'appareil ne doit pas produire de brouillage;
 - 2) L'appareil doit accepter tout brouillage radioélectrique subi, même si le brouillage est susceptible d'en compromettre le fonctionnement.

APPENDIX A DEVELOPMENT CABLE

The development cable is p/n ST101084-001.

Figure 23: Development Cable

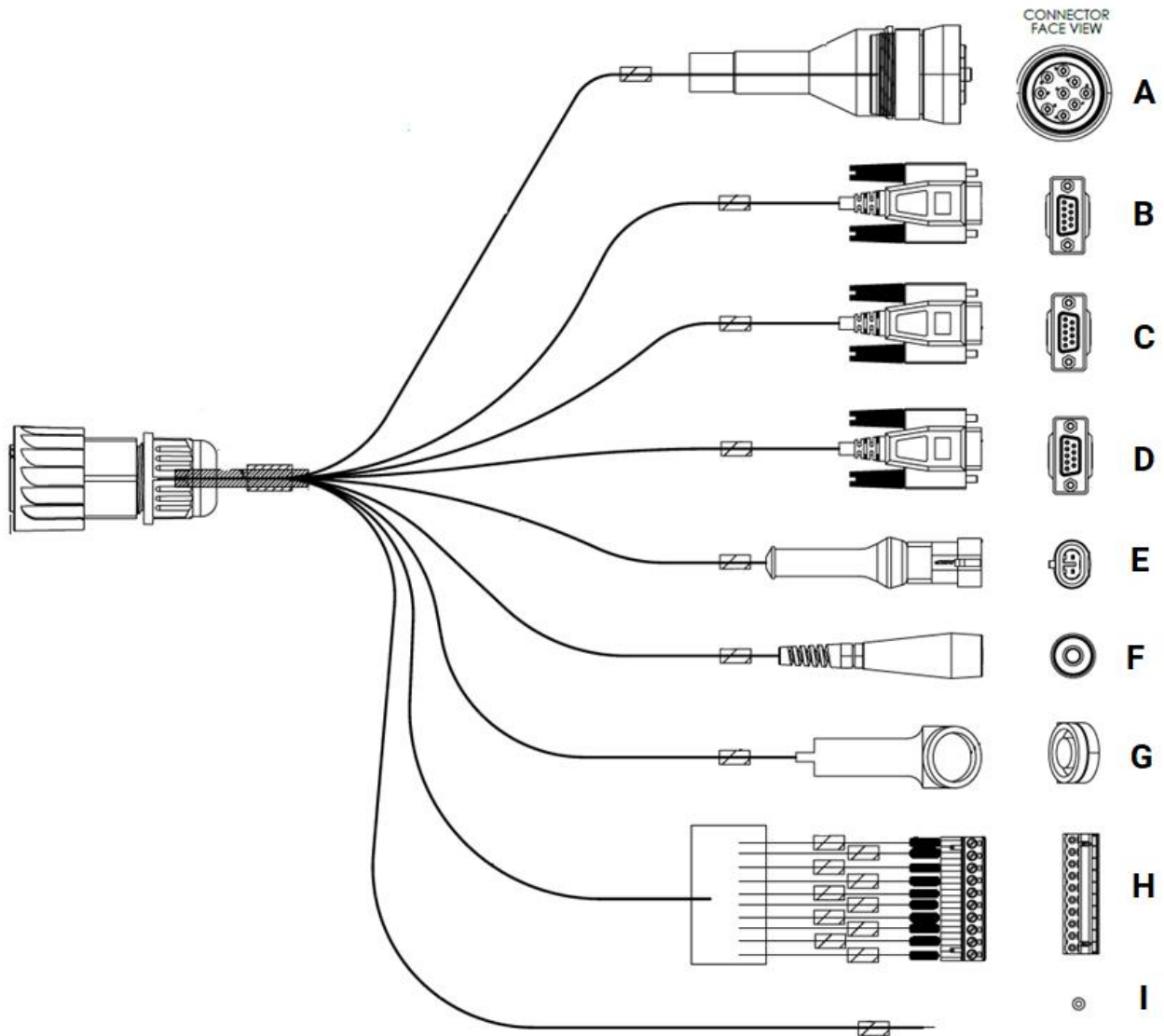
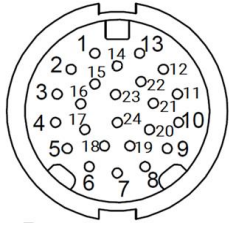
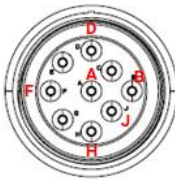
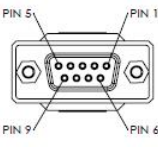
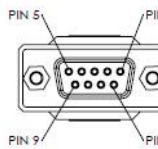
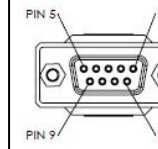
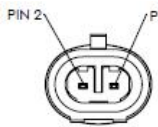
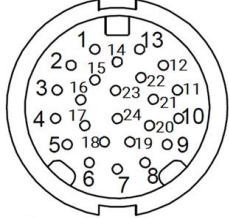

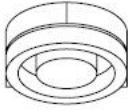
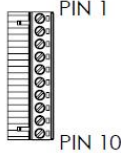
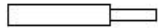

Table 7: Development Cable Connectors

Transceiver Connector	End A	End B	End C	End D	End E
					
PIN 9 - 1Wire Com					
PIN 10 - RS232 TX		PIN 2			
PIN 21 - RS232 RX		PIN 3			
PIN 22 - AUX RS232 TX			PIN 2		
PIN 13 - CAN 1 Low	PIN D				
PIN 14 - CAN 0 Low	PIN J				
PIN 1 - RS485 A				PIN 1	
PIN 24 - Dig IN 2					
PIN 16 - Dig IN 1					
PIN 4 - I/O_4					
PIN 5 - I/O_2					
PIN 6 _ Ground	PIN A and PIN E	PIN 5	PIN 5	PIN 5	PIN 2
PIN 7 - VEXT	PIN B				PIN 1
PIN 8 - Out 6					
PIN 18 - I/O_1					
PIN 17 - I/O_3					
PIN 3 - Dig IN 3					
PIN 15 - RS485 B				PIN 2	
PIN 23 - CAN 0 High	PIN H				
PIN 12 - CAN 1 High	PIN C				
PIN 11 - AUX RS232 RX			PIN 3		
PIN 20 - 1Wire Data					
PIN 19 - Out 5					
PIN 2 - Dig IN 4					

Transceiver Connector	End F	End G	End H	End I
				
PIN 9 - 1Wire Com		1Wire Common		
PIN 10 - RS232 TX				
PIN 21 - RS232 RX				
PIN 22 - AUX RS232 TX				
PIN 13 - CAN 1 Low				
PIN 14 - CAN 0 Low				
PIN 1 - RS485 A				
PIN 24 - Dig IN 2			PIN 8	
PIN 16 - Dig IN 1			PIN 7	
PIN 4 - I/O_4			PIN 4	
PIN 5 - I/O_2	Input 1			
PIN 6 - Ground	Ground		PIN 2	
PIN 7 - VEXT			PIN 1	
PIN 8 - Out 6			PIN 6	
PIN 18 - I/O_1				I/O_1
PIN 17 - I/O_3			PIN 3	
PIN 3 - Dig IN 3			PIN 9	
PIN 15 - RS485 B				
PIN 23 - CAN 0 High				
PIN 12 - CAN 1 High				
PIN 11 - AUX RS232 RX				
PIN 20 - 1Wire Data		1Wire Data		
PIN 19 - Out 5			PIN 5	
PIN 2 - Dig IN 4			PIN 10	



Project:
Northland Regional Council
May 31, 2021

OPTIONS



GIANT VOICE®

EMERGENCY SYSTEMS



*GV-CORE-NANO
Right, fast and
simple decisions
in critical
situations*



Mounting optional GV-CORE-NANO-RM

MINI CONTROL UNIT GV-CORE-NANO

The GV-CORE-NANO is a device integrating the standard interacting functions of a system and its operators with advanced warning, communications and process automation functions. It can be implemented as a simple activation panel saving costs and space significantly.

The GV-CORE-NANO is the ideal device for activate tones, pre-recorded messages and Public Address in real time. With the touch interface you can manage the entire siren network communication.

The functionality of the GV-CORE-NANO control unit is given by the applications it contains, which are supplied according to a client's needs and selection. These applications are designed to be mutually and directly interconnected into the complex whole. Depending on the applications combinations, it is possible to create a tailor-made solution to suit a specific client.

FEATURES

- Touch screen control
- Friendly interface for user
- Activation of the desired tone by groups of sirens, individually or to the entire network
- Redundant and simultaneous communication controls: Radio, GSM, SAT, IP
- Checking the correct communication with the different sirens on different channels
- Access restricted by security codes
- Restriction of allowed functions according to entered code
- Possibility of integration with GV-EMS Emergency management system
- Desk top or rack mounting version

HSS

HSS Engineering A/S
Laegaardsvej 12 · 8520 Lystrup · Denmark
Phone + 45 7022 8844
www.hss.dk · info@hss.dk

ENGINEERING®
WARNING SYSTEM SOLUTIONS

MONITORING MANAGEMENT CONTROL

MOBILE APP

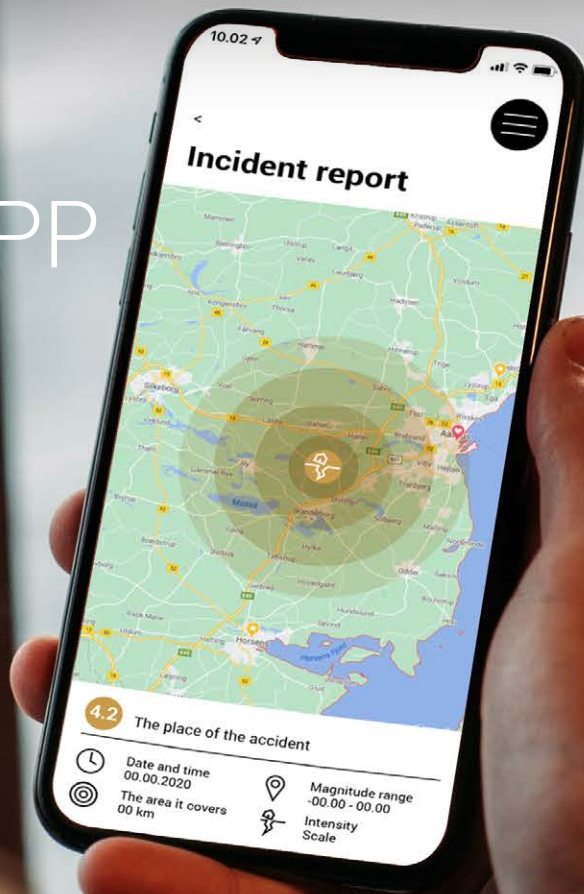

HSS



ENGINEERING®
WARNING SYSTEM SOLUTIONS

ALLOWS YOU TO SEND URGENT INFORMATION TO YOUR EMPLOYEES OR CITIZENS

**WE CUSTOMIZE
GV-MNA TO MEET OUR
CUSTOMERS' NEEDS**

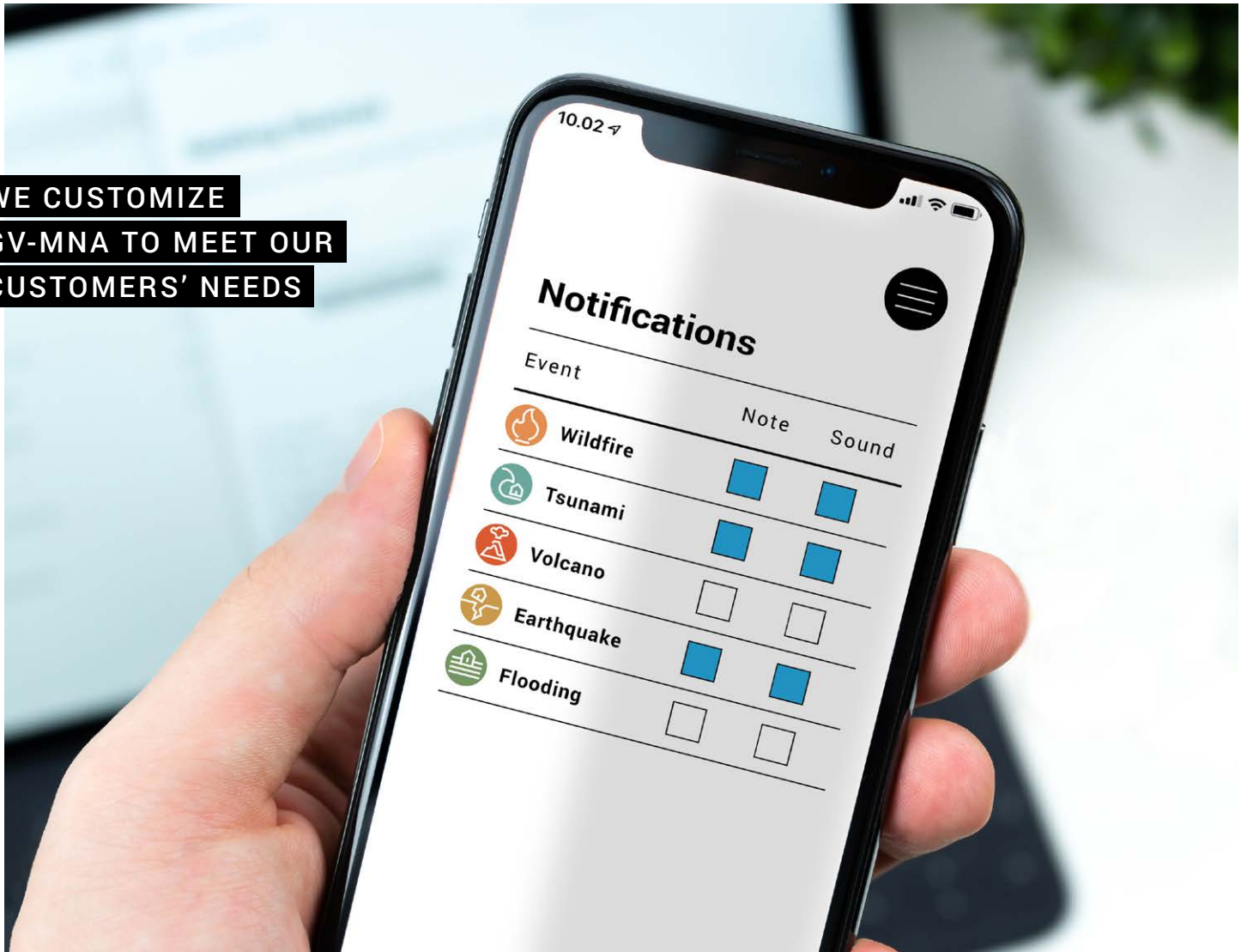

The mobile app Giant Voice® Mass Notification App, is an emergency alert system which allows you to send and receive information to your employees or citizens. The App has a user-friendly interface and has the ability to receive all kinds of alerts in a matter of seconds. We focus on alerting your staff or population regarding the emergency such as natural disasters, industrial disasters or a simple informative notification. The user can configure the type of notification depending on geographic area and type of emergency.

If alarms are activated because of a threat, your organization will be notified promptly via emergency alerts, that will inform you to evacuate towards a safer location.

Giant Voice® Mass Notification App provides a cost-effective solution with real-time messaging that can be used by any organization. The Giant Voice® Mass Notification App provides the ability to send and receive thousands of messages in seconds via SMS, Push Notification, and E-mail.



GIANT VOICE®

EMERGENCY SYSTEMS

ALERTS
PEOPLE TO
POSSIBLE
DANGER



ORDERING INFORMATION

Product Description

Mini control unit

Order No.

GV-CORE-NANO

Option

Product Description

Rack mounted mini control unit

Order No.

GV-CORE-NANO-RM

REV. B

APPLICATIONS

- Critical infrastructures (Dams, waterworks and civil protection facilities)
- Emergency services (fire-fighting, rescue units and police stations)
- Security services (banks, insurance companies and shopping centers)
- PA systems

TECHNICAL DATA

Input voltage	12V
Available ports	Audio 600 Ω balanced output, RS-232 serial, Ethernet and isolated contact inputs (optional)
Communications	Radio, GSM, SAT, IP
Mounting	Horizontal or vertical on the wall
Material	Aluminum front
Operating temperature	-25° C – +65° C
Dimensions	Width: 250 cm (98.43") Height: 180 cm (70.87") Depth: 80 cm (31.50")
Weight	Approx 1 kg

HSS

HSS Engineering A/S
Laegaardsvej 12 · 8520 Lystrup · Denmark
Phone + 45 7022 8844
www.hss.dk · info@hss.dk

ENGINEERING®
WARNING SYSTEM SOLUTIONS

PERSONALIZED NOTIFICATIONS

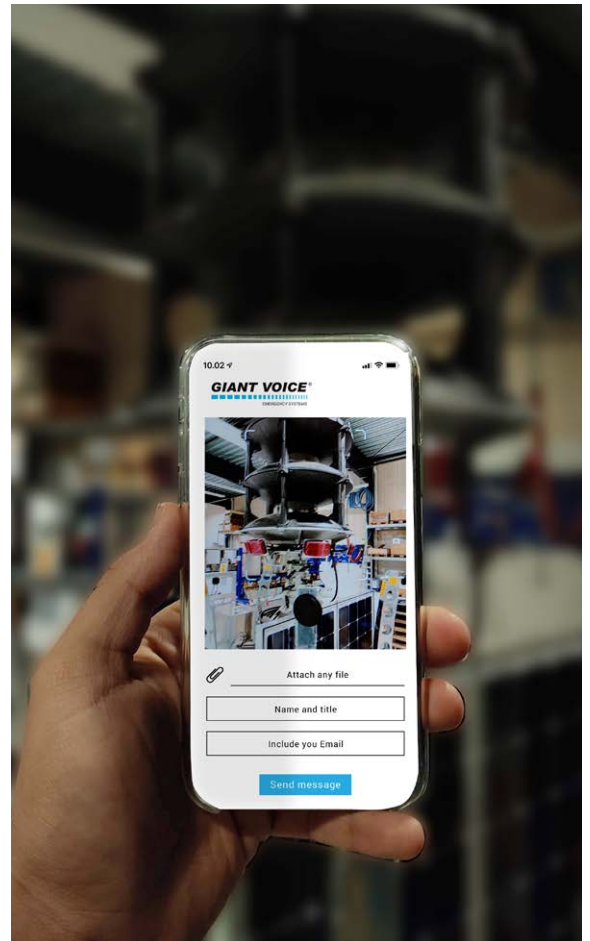
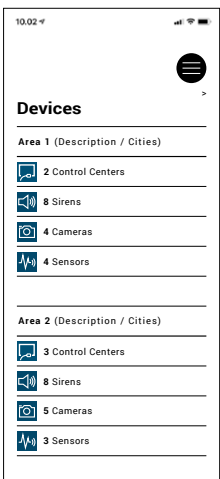
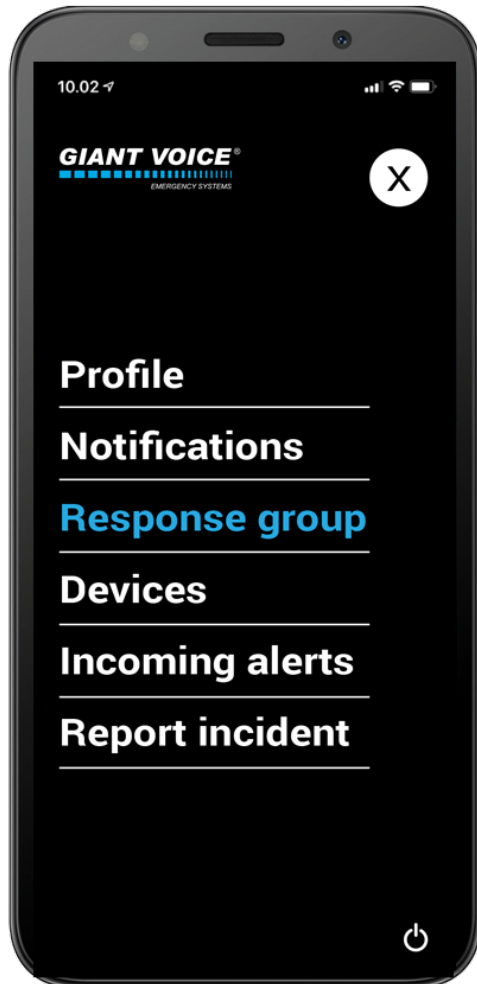
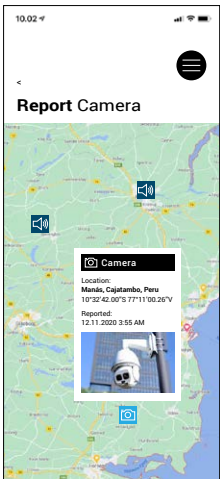
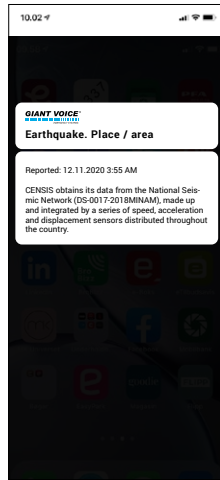
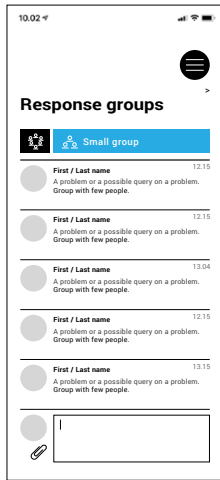
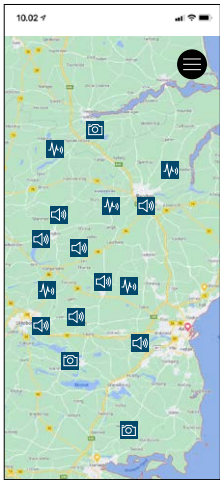

FEATURES

- Compatible with GV-EMS platform
- Apple: The latest version and 35 MB free space
- Android: The latest version and 35 MB free space
- Specific emergency status
- Notification depending on location
- Device status
- Unlimited number of users
- Notification of situation awareness
- Device failure notification
- Convertible web subscription
- Geo-location of personal
- Send and receive information



Omni-directional
six lighthouse
Super-LED VisuAlert

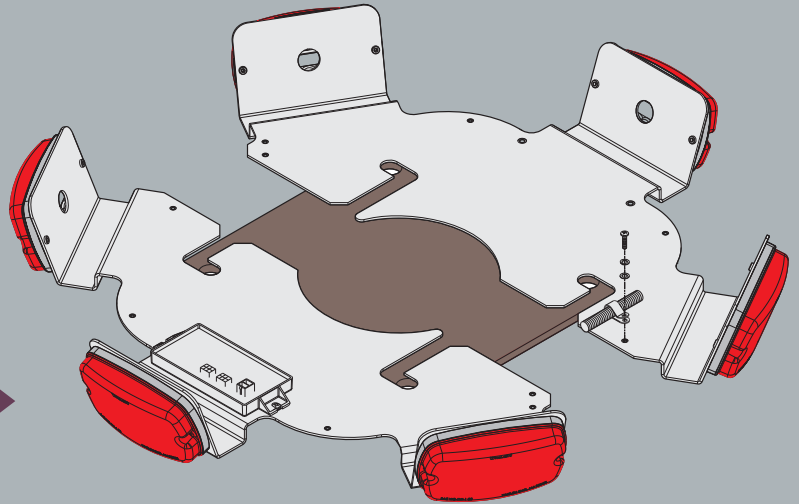

VISUAL LED WARNING

TWS-VISUALERT

Enhance your Voice and Siren Mass Notification System with an optional visual component: The Omni-directional Visual Lighting for TWS-290 & OA Series.

ORDERING INFORMATION

Product Description

TWS-Valert LED Light Cluster
Accessory for TWS Series.

Order No.

TWS-VALERT*

Options

Product Description

LED Controller

Order No.

LEDCTRL

* Denotes color Code:
A-Amber, B-Blue, C-Clear (white), R-Red.
REV. F

FEATURES

- VisuAlert Super-LED® mounts under a TWS-290 or Omni-Alert system
- Complete 360° highly effective LED warning
- VisuAlert illuminates with a designed flash pattern when siren is activated
- Cluster of six LED Whelen M6 Series warning lighthoods, 24 VDC
- All connections are waterproof
- All wiring is encased in protective sheathing, anchored to brackets to protect from damage
- Available in Red, Blue, White (Clear) or Amber
- Light source control module fully encapsulated and weatherproof
- Light source control module provides flash pattern selection and light synchronization
- Light source module covered by Whelen's two year warranty
- Bracket supports are 300 Series aluminium alloy in a high strength
- VisuAlert can be adapted to older ESC2020-controlled sirens
- 1.2 amps per light source @ 24 VDC.
- 2.5 amps total current draw when VisuAlert is operating
- Light source is greater than 6000 peak candela
- 84 flashes per minute
- M6 Series lighthouse dimensions: 109 mm H x 170 mm W x 35 mm D
- Weight: 12 kg
- IP rating: IP-66
- Operation temperature: -40° C to + 75° C

HSS



ENGINEERING®
WARNING SYSTEM SOLUTIONS

HSS Engineering A/S
Laegaardsvej 12 · 8520 Lystrup · Denmark
Phone + 45 7022 8844
www.hss.dk · info@hss.dk



GIANT VOICE®

EMERGENCY SYSTEMS

*The flexible
alternative for
temporary warning
installation*

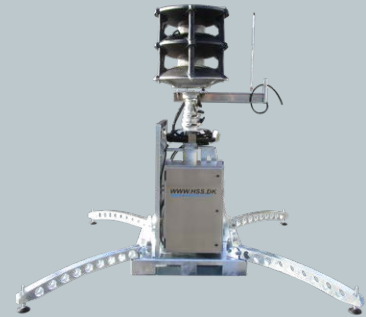

The Giant Voice® Deployable Unit is a flexible alternative for temporary warning system installation designed to meet your requirements even in harsh environments.

DEPLOYABLE UNIT GV-DPU

Featuring the TWS-292 high power voice and siren system. This Deployable Unit provides a 360° superior coverage. The GV-DPU is easy to handle and the solid supporting legs make it possible to extend the 6-meter lockable pneumatic telescopic mast on rough ground. The deployable unit is equipped with 2 x 100 W solar panels as well as a universal AC charger for recharging the batteries. This is a flexible solution that allows you to charge your deployable unit whenever it is needed. The deployable unit is equipped with a 25 W radio (VHF or UHF) and can be activated remotely from any Giant Voice® Control Centre equipment.

The Giant Voice® Deployable Unit meets NATO standard requirements and can easily be moved to any site with a forklift or similar machine for fast and reliable warnings. The chassis has been designed to reduce freight volume plus transportation costs and to improve handling and easy installation.

FEATURES

- TWS-292 - two omni-directional speaker cells
- 6-meter lockable pneumatic telescopic mast
- Two compartment aluminum cabinet
- 25 Watts 2-way radio incl. omni-directional 0dB gain antenna
- Local push button panel
- Solar Panel charging
- 115/230 VAC charging possibility
- UFC 4-021-01 compliant
- CAP (Common Alerting Protocol) compliant
- IPAWS compliant

HSS

HSS Engineering A/S
Laegaardsvej 12 · 8520 Lystrup · Denmark
Phone + 45 7022 8844
www.hss.dk · info@hss.dk

ENGINEERING®
WARNING SYSTEM SOLUTIONS



GIANT VOICE®

EMERGENCY SYSTEMS

ACOUSTIC PERFORMANCE

SPL @ 30 m: 115dB(C)

Estimated 80dB range: 366 m

Estimated 70dB range: 731 m

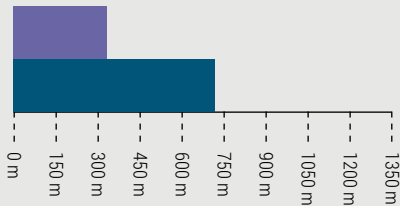

Note: 30 m performance levels listed represent repeatable results within +/-2 dB to stated levels. Estimated 80 dB perimeter is based on the Federal Emergency Management Agency's (FEMA) -10 dB per distance doubled path model.

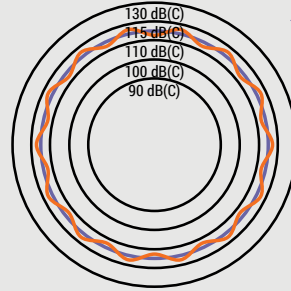

The superior design of the speaker cluster provides a true 360° high sound output throughout the entire frequency range.

ENVIRONMENTAL

Operating Temperature -35° C to +60° C

Storage Temperature -65° C to +125° C

Humidity, Non-Condensing 0 to 95%

TECHNICAL DATA

Output	115 dB(C) @ 30 meters/100'
Endurance	Minimum 30 minutes of full power output with our recommended batteries
Standard Tones	Wail, Whoop, Attack, Hi-Lo, Alert, Airhorn plus Public Address
System Test/Supervision	SI-Test®, Low Battery Alarm and more
Siren output (tones)	800 Watts
Siren output (voice)	1000 Watts
Standby current	40 mAmp
Power input	2 x 100 Watts solar panels or 110/220 VAC
Batteries	2 x 12 V 70 AH batteries (included)
Dimensions	Height: 252 cm Height erected: 660 cm Length: 113 cm Width: 113 cm Weight: 500 kg
Operating temperature	-35°C to 60°C (-31°F to 140°F)
Storage temperature	-65°C to 125°C (-85°F to 267°F)
Humidity, non-condensing	0 to 95%
Wind speed	Up to 27 m/s (without guide wires)

ORDERING INFORMATION

Product Description

Giant Voice Deployable Unit V5

Order No.

GV-DPU

Options

Product Description

Communication via UHF/VHF
For more information contact us.

REV. F

OPTIONS

- **VISU-ALERT:** Cluster of 6 LED lighthoods for a complete 360° highly effective warning
- **TWS-TL31R:** Top mounted LED strobe light
- **GV-FLOODLIGHT:** Upgrade your deployable unit with a cluster of LED floodlights for a combined mobile warning and light tower
- **GV-GSM-RTU:** For GSM activation

HSS

HSS Engineering A/S
Laegaardsvej 12 · 8520 Lystrup · Denmark
Phone + 45 7022 8844
www.hss.dk · info@hss.dk

ENGINEERING®
WARNING SYSTEM SOLUTIONS

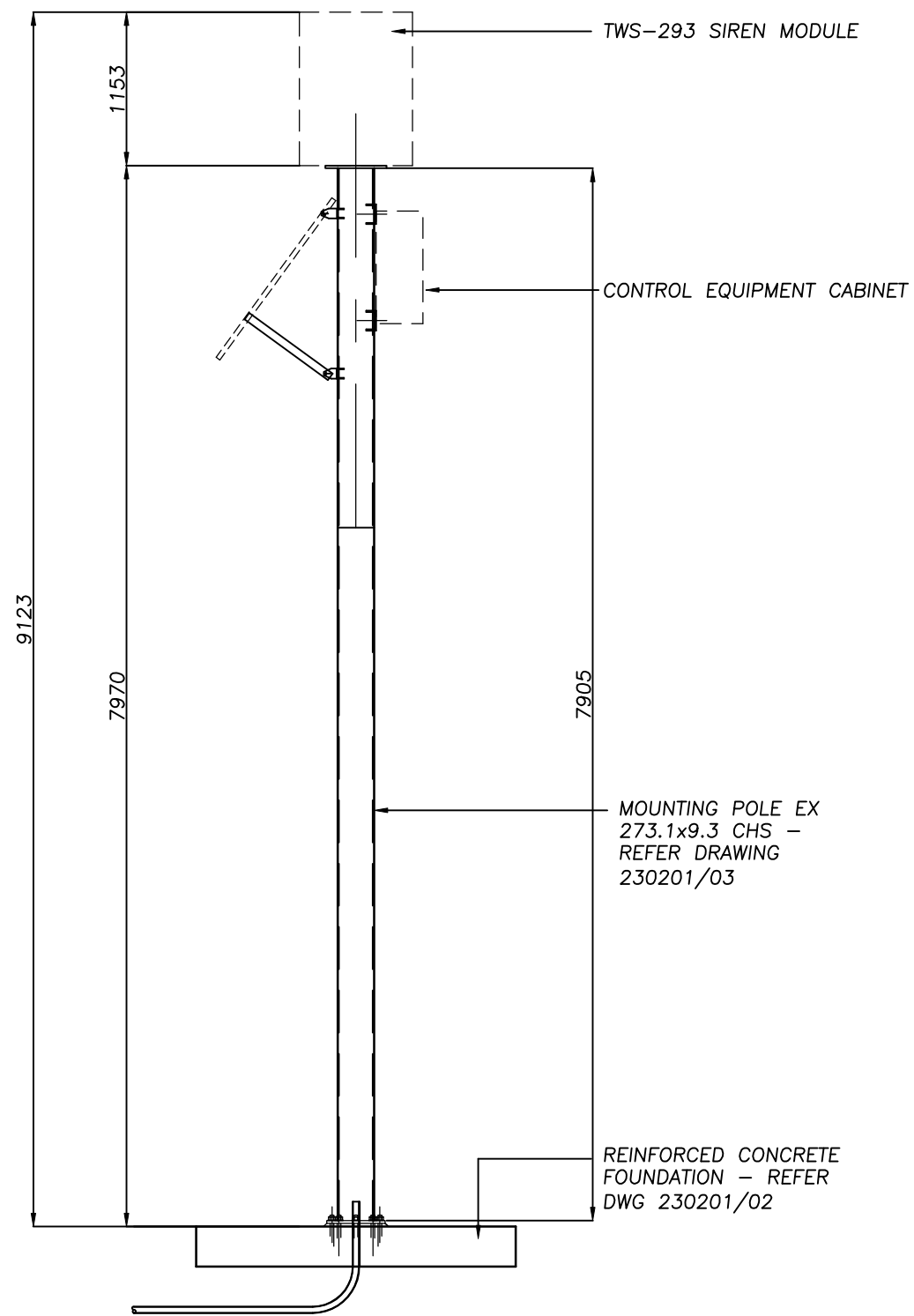

GENERAL ARRANGEMENT – TWS-293 SIREN
1:50

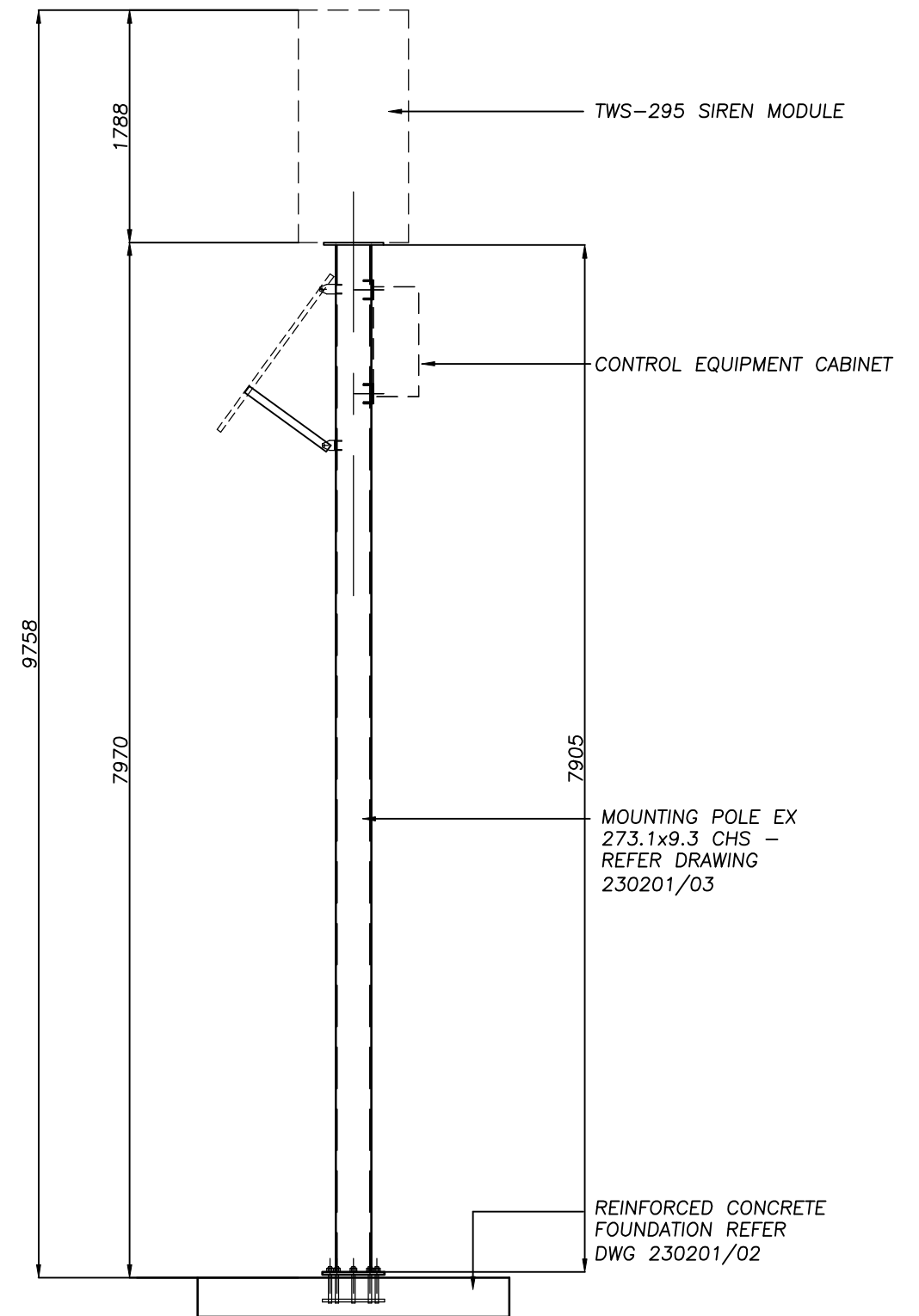

GENERAL ARRANGEMENT – TWS-295 SIREN
1:50

23 February 2023

Barker and Associates
Kerikeri CBD
Far North
Northland 0230

Attention: Makarena Dalton

Dear Makarena

Tsunami Warning Sirens - Compliance

Barker and Associates has engaged Marshall Day Acoustics to provide advice regarding tsunami warning sirens. The main request is to evaluate the proposed loudspeaker noise level emissions to enable comparison with the relevant District Plan noise limits across Northland.

We do not consider that District Plan noise rules should typically apply to tsunami warning sirens. We consider that tsunami warning siren noise is effectively a **positive noise effect on people. Requiring a tsunami siren to meet a typical daytime or night-time noise residential “noise limit” would not allow the tsunami warning system to work as intended and would not be in the interest of wider society.**

Tsunami warning sirens are intended to be a loud source of sound. A natural consequence of this is that there could be (and should be) a *technical breach* of a District Plan noise rule (if there is no specific exclusion for emergency sirens within the District Plan rule).

We do not consider that there will be any adverse noise effects arising from occasional testing or emergency use of the tsunami warning system where these technically breach any District Plan noise rules.

Notwithstanding the above, this letter provides initial information on noise emissions that can be used to establish locations in which a technical exceedance of the zone noise limits may occur. The letter is not intended to provide a very high level of detail on noise emissions from each individual loudspeaker tower¹. We have made a range of assumptions based on previous measurements to establish our design advice. As a result, our conclusions are generalised.

District plan noise rules: each district has quite different noise limits

We understand that the tsunami sirens are intended to be deployed in the:

- Kaipara District
- Far North District
- Whangarei District

The noise rules in each of these Districts differ even for similar types of zones. For instance, the *Rural Production* daytime noise rule in the Far North District is **65 dB L_{A10}** at the site boundary, whereas in Kaipara District the noise limit in the *Rural* zone is **50 dB L_{Aeq}** at the notional boundary.

The use of different noise standard descriptors (e.g. L_{A10} vs L_{Aeq}), the different numerical noise limits (e.g. 65 dB in the Far North vs 50 dB in Kaipara) and the different assessment position at which the noise limits apply

¹ Noise modelling of the individual loudspeaker towers has not been carried out for this assessment

(e.g. the site boundary in Far North and the notional boundary in Kaipara) means that it quickly becomes complex to determine where a technical breach of the noise limit will occur in each District.

Because of this we have prepared a “matrix of distances” that the planning assessment can use to estimate the properties where the relevant District Plan noise limits will be exceeded. These are tabulated and appended to this letter.

Exclusions within the District Plan

Ideally the operation and testing of tsunami warning sirens would be excluded from assessment against the District Plan zone noise limits, as these rules are inappropriate for tsunami sirens.

We note that the Whangarei District Plan make the following statement regarding warning sirens: *“The noise rules shall not apply to the following activities:...The operation of emergency service vehicles or emergency callout sirens.”* “Emergency callout sirens” is not defined in the District Plan² but the words appear to relate directly to the use of a tsunami siren³ In our view, this clause means that no noise limits apply to tsunami warning siren noise in any zones within Whangarei.

We are not aware of any specific exclusions in Kaipara or Far North District Plans but will review any clauses if provided to us. We recommend tsunami warning noise is excluded from compliance in any future district Plan revisions. We recommend Northland Regional Council submit on this matter or seek a plan change if required.

We have calculated the distances at which noise levels (in 5 dBA bands) will be complied with

Appendix A to Appendix C gives the approximate distances at which tsunami siren noise will be below specific noise levels. These have been given in 5 dBA tiers for the following scenarios:

Scenario A: Daytime testing

Scenario B: Daytime emergency operation

Scenario C: Night-time emergency operation

Noise levels for L_{Aeq} (Whangarei and Kaipara) and L_{A10} (Far North) are given separately so that the noise levels in each district can be separately evaluated.

The following assumptions have been used in our noise modelling.

- 145 dB L_{WA} based sound power level and omnidirectional source (refer Appendix D for technical details).
- 80% relative humidity. Noise levels in dry air conditions may be slightly lower.
- 80% soft ground at source, middle and receiver distances. Noise levels over hard ground (e.g. water) may be higher.
- Propagation calculated using International Standard ISO 9613-2:1996 *Acoustics - Attenuation of sound during propagation outdoors – Part 2: General method of calculation*. This standard calculated noise in conditions favourable to sound propagation such as downwind or temperature inversion conditions. Noise levels in upwind or temperature lapse conditions will be appreciably lower (refer Appendix E for technical details).
- No acoustic screening will occur. Noise levels behind ridgelines (where there is no line-of-sight to the tsunami siren) or behind buildings will be appreciably lower.

² The definitions section states that if a phrase is not defined it should take its common meaning from the concise Oxford English Dictionary.

³ Tsunami sirens are “calling out” a message and an alarm during an emergency and thus clearly fit within the everyday definition of this clause.

- Only one siren contributes to the noise level at each receiver.

The appendices show that:

- during **daytime testing** of sirens, the District Plan noise limits may be exceeded at up to 1,600 metres of the individual siren towers in some zones (e.g. rural, residential)
- during **daytime emergency operation**, the District Plan noise limits may be exceeded at up to 3,300 metres in some zones (e.g. residential, rural, coastal, etc.)
- during **night-time emergency operation**, the District Plan noise limits may be exceeded at up to 6,200 metres in some zones (e.g. residential, rural, coastal, etc.)

Refer to the appendices for more information on the distances at which specific noise levels will occur in each district.

We trust this information is useful. Please contact us if you have any questions.

Yours faithfully

MARSHALL DAY ACOUSTICS LTD



Peter Ibbotson

Acoustic Engineer

APPENDIX A DAYTIME TESTING

Table 1: Distance at which rating noise levels are likely to be met in Kaipara and Whangarei (L_{Aeq} limits) DURING DAYTIME TESTING

Distance at which rating noise level is met (assessed in accordance with NZS6802:2008). Rating Sound Power Level of 136 dB L _{WA,eq} (15 min)								
	75 dB L _{Aeq}	70 dB L _{Aeq}	65 dB L _{Aeq}	60 dB L _{Aeq}	55 dB L _{Aeq}	50 dB L _{Aeq}	45 dB L _{Aeq}	40 dB L _{Aeq}
DAY TESTING	250m	400m	600m	850m	1200m	1600m	N/A	N/A
<i>Kaipara Zone Examples</i>	If emitted from an Industrial zone: <i>Industrial</i>			If emitted from a Commercial zone: <i>Commercial</i>	If emitted from an Industrial zone: <i>Residential, Rural, Māori Purpose zone</i>	If emitted from Rural, Residential, Commercial, Māori Purpose: <i>Rural, Residential, Māori Purpose</i>		
<i>Whangarei Zone Examples</i> [NOTE THAT EMERGENCY SIRENS EXCLUDED IN THIS PLAN]	<i>Heavy Industrial, Settlement Zone Industrial, SRIZ</i>		<i>Light Industry, Commercial, Sport and Active Recreation, Shopping Centre, Hospital, Airport</i>	<i>City Centre, Waterfront², Mixed Use, Local Centre, Settlement Centre</i>	If emitted from Port, Settlement, Heavy Industrial, light industrial, commercial, Sport and Active Recreation: <i>Residential, Neighbourhood Centre, Natural Open Space, Open Space, Rural Production, Rural Lifestyle, Settlement, Future Urban.</i>	If emitted from most other zones: <i>Residential, Neighbourhood Centre, Rural Lifestyle, Settlement, Future Urban</i>		
					If emitted from most other zones: <i>Open Space, Rural Production.</i>			

Notes:

1. Zone examples should be checked by the consultant planner for accuracy. Not all zones in each District are given
2. The District Plans include some errors. If there is question over what limit should apply, we have used our discretion (for instance there are conflicting limits for Rural Production zone in Whangarei)
3. In some Districts, the limit varies depending on the zone the noise source is located in.

Table 2: Distance at which rating noise levels are likely to be met in Far North (L_{A10} limits) DURING DAYTIME TESTING

Distance at which rating noise level is met (assessed in accordance with NZS6802:2008). Rating sound power level of 133 dB L _{WA,10} (15 min)								
	75 dB L _{A10}	70 dB L _{A10}	65 dB L _{A10}	60 dB L _{A10}	55 dB L _{A10}	50 dB L _{A10}	45 dB L _{A10}	40 dB L _{A10}
DAY TESTING	180m	300m	450m	700m	950m	1,400m	N/A	N/A
<i>Far North Zone Examples</i>			<p>If emitted from a Rural Production zone: Rural Production, Residential, Coastal Residential, Russell Township [site boundary] - other rural or coastal zone [notional boundary]</p> <p>If emitted from a Commercial zone: Commercial [site]</p> <p>If emitted from an Industrial Zone: Industrial [site]</p>		<p>If emitted from a Rural Living, Commercial, Industrial, Minerals or any Coastal zone: - Coastal Residential, Residential, Russell Township [site boundary] - any Rural or Coastal zone [notional boundary]</p>	<p>If emitted from a Residential zone: - Residential [site boundary] - any Rural or Coastal zone [notional boundary]</p>		

Notes:

1. Zone examples should be checked by the consultant planner for accuracy. Not all zones are given.
2. In the FNDC, the limit varies depending on the zone the noise source is located in (for instance if a siren was located in a *Rural Production* zone, it would need to meet 65 dB L_{A10} at another *Rural Production* zone during the day, but if a siren was located in a *Rural Living* zone the limit would be 55 dB L_{A10} at a *Rural Production* zone during the day).

APPENDIX B DAYTIME EMERGENCY OPERATION

Table 3: Distance at which rating noise levels are likely to be met in Kaipara and Whangarei (L_{Aeq} limits) during DAYTIME EMERGENCY OPERATION

Distance at which rating noise level is met (assessed in accordance with NZS6802:2008). Rating Sound Power Level of 145 dB L _{WA,eq} (15 min)								
	75 dB L _{Aeq}	70 dB L _{Aeq}	65 dB L _{Aeq}	60 dB L _{Aeq}	55 dB L _{Aeq}	50 dB L _{Aeq}	45 dB L _{Aeq}	40 dB L _{Aeq}
DAY EMERGENCY	550m	800m	1,100m	1,500m	2,000m	2,600m	N/A	N/A
<i>Kaipara Zone Examples</i>	<i>If emitted from an Industrial zone: Industrial</i>			<i>If emitted from a Commercial zone: Commercial</i>	<i>If emitted from an Industrial zone: Residential, Rural, Māori Purpose zone</i>	<i>If emitted from Rural, Residential, Commercial, Māori Purpose: Rural, Residential, Māori Purpose</i>		
<i>Whangarei Zone Examples [NOTE THAT EMERGENCY SIRENS EXCLUDED IN THIS PLAN]</i>	<i>Heavy Industrial, Settlement Zone Industrial, SRIZ</i>		<i>Light Industry, Commercial, Sport and Active Recreation, Shopping Centre, Hospital, Airport</i>	<i>City Centre, Waterfront², Mixed Use, Local Centre, Settlement Centre</i>	<i>If emitted from Port, Settlement, Heavy Industrial, Light Industrial, Commercial, Sport and Active Recreation: Residential, Neighbourhood Centre, Natural Open Space, Open Space, Rural Production, Rural Lifestyle, Settlement, Future Urban.</i>	<i>If emitted from most other zones: Residential, Neighbourhood Centre, Rural Lifestyle, Settlement, Future Urban</i>		
					<i>If emitted from most other zones: Open Space, Rural Production.</i>			

Notes:

1. Zone examples should be checked by the consultant planner for accuracy. Not all zones in each District are given
2. The District Plans include some errors. If there is question over what limit should apply, we have used our discretion (for instance there are conflicting limits for Rural Production zone in Whangarei)
3. In some Districts, the limit varies depending on the zone the noise source is located in.

Table 4: Distance at which rating noise levels are likely to be met in Far North (L_{A10} limits) DAYTIME EMERGENCY OPERATION

Distance at which rating noise level is met (assessed in accordance with NZS6802:2008). Rating sound power level of 150 dB L _{WA,10} (15 min)								
	75 dB L _{A10}	70 dB L _{A10}	65 dB L _{A10}	60 dB L _{A10}	55 dB L _{A10}	50 dB L _{A10}	45 dB L _{A10}	40 dB L _{A10}
DAY EMERGENCY	800m	1,100m	1,500m	2,000m	2,600m	3,300m	N/A	N/A
<i>Far North Zone Examples</i>			<p>If emitted from a Rural Production zone: Rural Production, Residential, Coastal Residential, Russell Township [site boundary] - other rural or coastal zone [notional boundary]</p> <p>If emitted from a Commercial zone: Commercial [site]</p> <p>If emitted from an Industrial Zone: Industrial [site]</p>		<p>If emitted from a Rural Living, Commercial, Industrial, Minerals or any Coastal zone: - Coastal Residential, Residential, Russell Township [site boundary] - any Rural or Coastal zone [notional boundary]</p>	<p>If emitted from a Residential zone: - Residential [site boundary] - any Rural or Coastal zone [notional boundary]</p>		

Notes:

1. Zone examples should be checked by the consultant planner for accuracy. Not all zones are given.
2. In the FNDC, the limit varies depending on the zone the noise source is located in (for instance if a siren was located in a *Rural Production* zone, it would need to meet 65 dB L_{A10} at another *Rural Production* zone during the day, but if a siren was located in a *Rural Living* zone the limit would be 55 dB L_{A10} at a *Rural Production* zone during the day).

APPENDIX C NIGHT-TIME EMERGENCY OPERATION

Table 5: Distance at which rating noise levels are likely to be met in Kaipara and Whangarei (L_{Aeq} limits) during NIGHT-TIME EMERGENCY OPERATION

Distance at which rating noise level is met (assessed in accordance with NZS6802:2008). Rating sound power level of 150 dB L _{WA,eq} (15 min)								
	75 dB L _{Aeq}	70 dB L _{Aeq}	65 dB L _{Aeq}	60 dB L _{Aeq}	55 dB L _{Aeq}	50 dB L _{Aeq}	45 dB L _{Aeq}	40 dB L _{Aeq}
NIGHT EMERGENCY	800m	1,100m	1,500m	2,000m	2,600m	3,300m	4,200m	5,100m
<i>Kaipara Zone Examples</i>	<i>If emitted from an Industrial zone: Industrial</i>			<i>If emitted from a Commercial zone: Commercial</i>			<i>If emitted from an Industrial zone: Residential, Rural, Māori Purpose zone</i>	<i>If emitted from Rural, Residential, Commercial, Māori Purpose: Rural, Residential, Māori Purpose</i>
<i>Whangarei Zone Examples [NOTE THAT EMERGENCY SIRENS EXCLUDED IN THIS PLAN]</i>	<i>Heavy Industrial, Settlement Zone Industrial, SRIZ</i>			<i>Light Industry, Commercial, Sport and Active Recreation, Shopping Centre, Hospital, Airport</i>	<i>City Centre, Waterfront²</i>	<i>Mixed Use, Local Centre, Settlement Centre</i> <i>If emitted from most other zones: Residential, Neighbourhood Centre, Rural Lifestyle, Settlement, Future Urban</i>	<i>If emitted from Port, Settlement, Heavy Industrial, Light Industrial, Commercial, Sport and Active Recreation: Residential, Neighbourhood Centre, Natural Open Space, Open Space.</i>	<i>If emitted from most other zones: Open Space, Rural Production, Residential, Neighbourhood Centre, Rural Lifestyle, Settlement, Future Urban</i>

Notes:

1. Zone examples should be checked by the consultant planner for accuracy. Not all zones in each District are given
2. The District Plans include some errors. Where there is question over what limit should apply, we have used our discretion (for instance there are conflicting limits for Rural Production zone in Whangarei)
3. In these districts, the limit varies depending on the zone the noise source is located in.

Table 6: Distance at which rating noise levels are likely to be met in Far North (L_{A10} limits) during NIGHT-TIME EMERGENCY OPERATION

Distance at which rating noise level is met (assessed in accordance with NZS6802:2008). Rating sound power level of 155 dB L _{WA,10} (15 min)								
	75 dB L _{Aeq}	70 dB L _{Aeq}	65 dB L _{Aeq}	60 dB L _{Aeq}	55 dB L _{Aeq}	50 dB L _{Aeq}	45 dB L _{Aeq}	40 dB L _{Aeq}
NIGHT EMERGENCY	1,100m	1,500m	2,000m	2,600m	3,300m	4,200m	5,100m	6,200m
<i>Far North Zone Examples</i>					<i>If emitted from a Commercial zone: Commercial [site]</i>		<i>If emitted from a Rural Production zone: Rural Production, Residential, Coastal Residential, Russell Township [site boundary] - other rural or coastal zone [notional boundary]</i>	
					<i>If emitted from an Industrial Zone: Industrial [site]</i>		<i>If emitted from a Commercial, Industrial, Coastal or Residential zone: - Residential, Coastal Residential, Russell Township [site boundary] - other rural or coastal zone [notional boundary].</i>	

Notes:
1. Zone examples should be checked by the consultant planner for accuracy. Not all zones are given.

APPENDIX D SIREN SYSTEM SELECTIONS:

We do not expect the siren systems to deliver the sound pressure levels claimed (when considered as an $L_{Aeq(t)}$ level). Two siren system models are proposed to be used. These are the HSS Engineering TWS-293 and TWS-295. The manufacturer datasheet provides the following acoustic data:

- TWS-293 149 dBC @ 1m, 119 dBC @ 30m
- TWS-295 153 dBC @ 1m, 123 dBC @30m

The District Plan limits use “A-weighting” whereas the stated HSS Engineering data sheets state sound pressure levels in terms of “C-weighting”. Our evaluation of other tsunami siren tests is that there is a negligible difference between the A- and C-weightings when measured in the field (less than 1 decibel of difference within 50 metres of the sirens). On this basis, we consider that any C-weighted specification can simply be read as an A-weighted level⁴.

The HSS Engineering sound pressure levels given are determined in accordance with ISO13475-1. This standard provides a test methodology for measurement of loudspeaker level. However the level stated by the manufacturer does not clarify whether the stated level is given in terms of L_{AFmax} , $L_{Aeq(t)}$ or perhaps some other value such as L_{Cpeak} . The relevant District Plan noise limits are given in L_{Aeq} (or L_{A10} in the case of Far North)⁵ and it is necessary to evaluate noise using these parameters⁶.

We consider it likely that the level quoted by HSS refers to the L_{AFmax} (or possibly a L_{Zpeak}) noise level measured using a test signal in standardised conditions – we do not expect that the siren systems could generate L_{Aeq} noise levels over the duration of the test signal at sound pressure levels of 119 to 123 dB at 30 metres. Such noise levels would be extremely high and would be very unpleasant (and potentially debilitating) to anyone within 50 metres of the sirens who was not wearing hearing protection.

Our experience with similarly designed siren systems operating in the field is that sound pressure levels will be in the order of 80 - 82 dB $L_{Aeq(1 min)}$ at 150 metres and around 90 - 91 dB $L_{Aeq(1 min)}$ at 75 metres during tests⁷. This can be conservatively modelled as a sound power level of 145 dB $L_{WA,eq(1 min)}$ ⁸. Based on our experience, we have calculated noise emissions, for this assessment, based on a simple omnidirectional loudspeaker with the following sound power level:

Table 7: Octave Band Noise Level Results

Source	Sound Power Level dB $L_{WA,eq(1 min)}$							dBA
	63	125	250	500	1000	2000	4000	
HSS Loudspeakers (used both TWS-295 and TWS-293)	-	-	-	140	140	140	-	145

⁴ The warning signal is broadly composed of a sweep of frequencies from around 500 to 2 kHz and as such there is little difference between A and C weighted levels.

⁵ The L_{A10} and L_{Aeq} noise levels are numerically quite similar, whereas L_{AFmax} and L_{Zpeak} levels are numerically much higher.

⁶ The District Plan night-time rules also have limits on L_{AFmax} noise levels. However in the case of a tsunami warning siren, the L_{A10} or L_{Aeq} night -time rules would control where a technical breach will occur.

⁷ L_{AFmax} noise levels would be around 14 decibels higher than this and L_{Zpeak} levels would be around 21 decibels higher than this

⁸ The sound power level is the amount of sound energy produced if you conceptualise the source as a very small point. As sound levels drop with respect to distance, you get the quoted sound pressure levels (L_{Aeq} or L_{A10}) at different distances. In this case with respect to a 145 dB L_{WA} , it allows for a small safety factor as this sound power level would return a sound pressure level of around 88 dB $L_{Aeq(1 min)}$ at 150 metres from the base of the loudspeaker support

APPENDIX E CALCULATIONS IN ACCORDANCE WITH NZS6802

All District Plans reference New Zealand Standard NZS6802⁹. This standard sets out how environmental sound should be assessed in New Zealand for typical environmental sources.

The NZS6802 standard is not particularly well suited to the assessment of tsunami siren noise. However the District Plan requires the use of this standard and thus we have used it based on the following assumptions:

Testing

- The swept-sine nature of the siren would be subjectively tonal (but not objectively tonal) and a special audible characteristics correction of + 5dBA should therefore apply to all testing and operation.
- The NZS6802:2008 assessment period is 15 minutes. **Testing** of the tsunami sirens during the daytime has previously involved two cycles of around one minute of tsunami alarm signal (two minutes of signal in total). This correlates to a rating sound power level of 136 dB $L_{WA,eq(15\ min)}$ and 133 dB $L_{WA,10(15\ min)}$ ¹⁰
- A duration correction for a 15-hour day period can be used. A duration correction of -5 decibels would be appropriate during the day in all districts.
- Testing would occur twice per year during the statutory daytime. Testing of sirens would not occur at night.

Operation (Emergency Evacuation)

- During emergency operation (i.e. in an emergency tsunami evacuation) it is assumed that the siren could operate for at least a full 15-minute assessment period but for less than 5 hours of the day period. A full duration correction is considered appropriate during the daytime. This correlates to a rating sound power level of 145 dB $L_{WA,eq(15\ min)}$ and 150 dB $L_{WA,10(15\ min)}$ ¹¹.
- No duration correction can be applied at night. This correlates to a rating sound power level of 150 dB $L_{WA,eq(15\ min)}$ and 155 dB $L_{WA,10(15\ min)}$ ¹².

⁹ The Far North District Plan still references the 1991 version of the standard, even though this was superceded in 2008. The Kaipara and Whangarei District Plan versions reference the current 2008 version of the standard. An important difference between the standard is the way that special audible characteristics are applied. The 1991 version reduces the limit by 5 dBA, whereas the 2008 version adds a 5 decibel penalty to the assessed noise level. Both approaches are effectively the same, but use a different methodology. To avoid confusion in this assessment we have used the 2008 approach and added any special audible characteristics correction to the assessed noise level.

¹⁰ This is the sound power level over a fifteen-minute period when the periods of noise (2 minutes) and quiet (13 minutes) are included. The L_{A10} value is less than the L_{Aeq} level as the signal is only present for two minutes of the fifteen-minute test period during the daytime – this has been determined from previous measurements carried out of tsunami siren operation elsewhere in NZ. The rating sound power level includes the SAC and duration correction for the day period.

¹¹ This is the sound power level assuming the siren operates continuously (warning alarm with speech between) for less than five hours during an evacuation. The L_{A10} value is higher than the L_{Aeq} value as the periods of louder noise (alarm) are present for longer during the assessment period. The rating sound power level includes the SAC and duration correction for the day period.

¹² This is the sound power level assuming the siren operates continuously (warning alarm with speech between) over any 15-minute period at night. It is the same as the daytime sound power level, but without any -5 decibel duration correction.

Appendix 5 - Rules Checklist

Proposal: Northland Tsunami Rollout
 Address: Road Reserve, Thomas Street, Mangōnuī
 District Plan: Far North District Plan

Siren 78		Road Reserve, Thomas Street, Mangōnuī	
Operative Zone	Residential Zone		
Proposed Zone	General Residential		
Operative Overlays/Controls	None		
Proposed Overlays/Controls	Coastal Environment		
Designations	None		
Rule	Compliance	Non-Compliance	
Coastal Residential Zone			
7.6.5.1.1 RELOCATED BUILDINGS	N/A – no reallocated buildings proposed.		
7.6.5.1.2 RESIDENTIAL INTENSITY	N/A – No residential units proposed.		
7.6.5.1.3 SCALE OF ACTIVITIES	N/A - Not Relevant to the proposal.		
7.6.5.1.4 BUILDING HEIGHT		Does not comply Siren 78 exceeds the 8m permitted standard is siren 78 height will be 9.8m. Discretionary	
7.6.5.1.5 SUNLIGHT		Does not comply Siren 78 is 3m from the nearest boundary so does not meet the recession plane permitted standards. Discretionary	
7.6.5.1.6 STORMWATER MANAGEMENT	Complies Siren 88 has a base measurement of 6.25 m ² so is under the permitted impermeable surfaces area of 50% gross site area maximum Permitted		
7.6.5.1.7 SET BACK FROM BOUNDARIES		Does not comply	

Rule	Compliance	Non-Compliance
		Siren 88 is within the road reserve and therefore exceeds the permitted minimum 3m setback from the road boundary. Restricted Discretionary
7.6.5.1.8 SCREENING FOR NEIGHBOURS - NON-RESIDENTIAL ACTIVITIES	N/A - Not Relevant to the proposal.	
7.6.5.1.9 OUTDOOR ACTIVITIES	N/A – Not Relevant to the proposal.	
7.6.5.1.10 VISUAL AMENITY		
7.6.5.1.11 TRANSPORTATION	N/A –Traffic, Parking and Access rules not relevant to the proposal.	
7.6.5.1.12 SITE INTENSITY - NON-RESIDENTIAL ACTIVITIES	N/A - Not Relevant to the proposal.	
7.6.5.1.13 HOURS OF OPERATION - NON-RESIDENTIAL ACTIVITIES	N/A - no hours of operation proposed	
7.6.5.1.14 KEEPING OF ANIMALS	N/A – no keeping of animals proposed	
7.6.5.1.15 NOISE		Does not comply Siren 88 will exceed the permitted noise thresholds. Restricted Discretionary
7.6.5.1.16 HELICOPTER LANDING AREA	N/A – no helicopter landing area proposed.	
7.6.5.1.17 BUILDING COVERAGE	Complies Siren 88 has a base measurement of 6.25 m ² so is under the maximum total Building Coverage of a site of 45% or 900m ² Permitted	
Natural and Physical Resources		
12.1 LANDSCAPES AND NATURAL FEATURES	N/A – outstanding landscape and natural features not identified on proposed site.	
12.2 INDIGENOUS FLORA AND FAUNA	N/A –indigenous Flora and Fauna not identified on proposed site.	
12.3.6.1.3 EXCAVATION AND/OR FILLING, EXCLUDING MINING AND QUARRYING, IN THE RESIDENTIAL, INDUSTRIAL, HORTICULTURAL PROCESSING, COASTAL	Complies 3.5m ³ of earthworks are proposed over an area of 6.5m ² is for Siren 88	

Rule	Compliance	Non-Compliance
RESIDENTIAL AND RUSSELL TOWNSHIP ZONES	proposal. This is us under the maximum volume of 200m ³ and the maximum permitted cut and fill height of 3m. Permitted	
12.4 NATURAL HAZARDS	N/A – Natural Hazards not identified on proposed site.	
12.5 HERITAGE	N/A – Heritage sites not identified on proposed site.	
12.7.6.1.1 SETBACK FROM LAKES, RIVERS AND THE COASTAL MARINE AREA	Complies Siren 88 is set back approximately 150m from the Coastal Marine Area. This exceeds the 26m minimum set back. Permitted	
12.8 HAZARDOUS SUBSTANCES	N/A – Rules in this chapter are not relevant to the proposal.	
12.9 RENEWABLE ENERGY AND ENERGY EFFICIENCY	N/A – Rules in this chapter are not relevant to the proposal.	
Proposed FNDC plan – rules that have immediate legal effect.		
EW-R12 Earthworks and the Discovery of Suspected Sensitive Material	Complies	
EW-R13 Earthworks and Erosion and Sediment Control	Complies	
EW-S3 Accidental Discovery Protocol	Complies	
EW-S5 Erosion and Sediment Control	Complies	

New Siren Coverage Maps

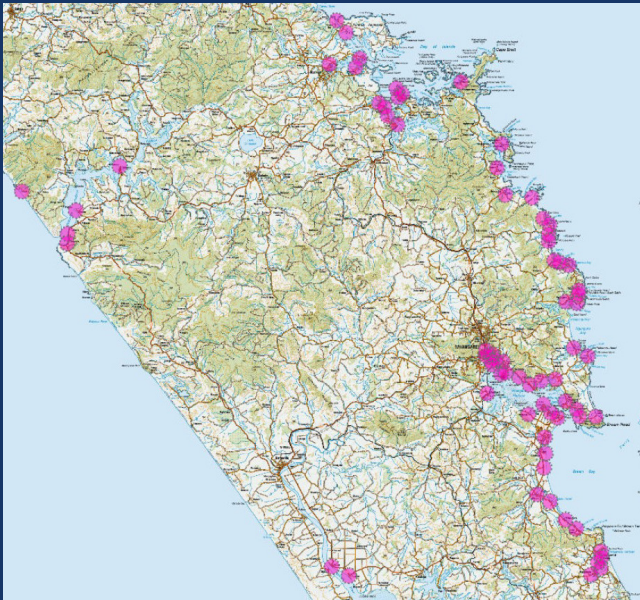
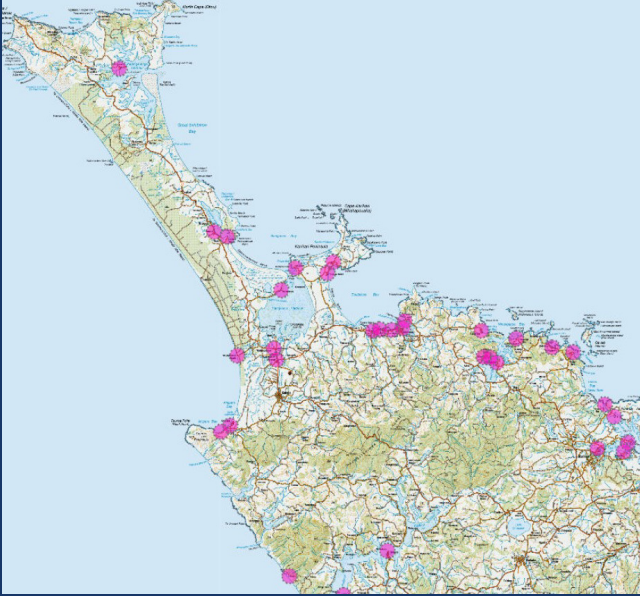

Legend

 Approximate siren sound coverage



**NORTHLAND
EMERGENCY MANAGEMENT**

GROUP

GET READY

.govt.nz



National Emergency
Management Agency
Te Rakau Whakamarumaru

www.civildefence.govt.nz



Northland
REGIONAL COUNCIL

www.nrc.govt.nz

0800 002 004



Whangarei

District Council

www.wdc.govt.nz

0800 002 004



Kaipara te Oranganui

**KAIPARA
DISTRICT**

Two Oceans Two Harbours

www.kaipara.govt.nz

0800 727 059



**Far North
District Council**

Te Kaunihera o Tai Tokerau ki te Raki

www.fndc.govt.nz

0800 920 029



Northland Tsunami Siren Project

WHAT YOU NEED TO KNOW

Northland's tsunami sirens are being replaced
FIND OUT MORE INSIDE

Tsunami sirens in Northland

The current Northland tsunami siren network is made up of over 200 sirens located along Northland's coastline.

This network is an initial warning system to alert coastal communities of distant source Tsunami threats.

The sirens are owned by the local District Councils and managed by the Northland Civil Defence Emergency Management Group on behalf of all Northlanders.

The current system is coming to the end of its expected life and is set to be replaced with up-to-date technology.

Some areas across Northland that cannot hear the outdoor sirens also have indoor sirens. These are activated simultaneously with the outdoor sirens.

Tsunami siren replacement project

To help better protect Northlanders against the threat of Tsunami and meet the new siren guidelines, a joint project was initiated by all four Northland councils, to replace the existing sirens with new models that are standard compliant. The project is set to replace the current sirens with 96 new sirens – starting in 2023 and rolling out over the next couple of years.

The new sirens are quite different from the existing ones. They have much greater sound coverage, can provide voice messaging as well as multi-tone siren sounds, have back-up solar power, and are activated separately from the mains power via the cell phone network or satellite.

As they are independent of the power grid, they will also be on their own poles, and because they have greater sound coverage, we'll require fewer sirens in fewer, more effective locations.

The Northland Civil Defence Emergency Management Group has been working with the siren suppliers – HSS Engineering – to identify the best locations for the new sirens that will provide the best coverage across the region.

However, the project remains about updating what we have, while improving the coverage of existing areas, not adding additional areas.

The current indoor sirens will also continue to be activated simultaneously with the outdoor sirens for the foreseeable future.

For more information on the project head to: www.nrc.govt.nz/tsunami

Seeking further information

Whether it's the current sirens or the new sirens, when you hear one, the first thing to do is to seek further information. Here are some of the key places to check:

- Emergency Mobile Alert or Red Cross Hazard App notification. Find out more at: www.nrc.govt.nz/cdalert
- Northland Civil Defence Facebook page ([civildefencenorthland](https://www.facebook.com/civildefencenorthland))
- Northland council websites, such as www.nrc.govt.nz/civildefence
- TV and Radio
- Other social media sites

Follow the instructions given by Civil Defence and spread the word to people you think may be at risk.

Remember, tsunami sirens don't necessarily mean you need to evacuate the area right away. They do mean you need to find out what the level of threat is.

Make sure you stay up-to-date and check multiple sources during the alert if you can. No single source of information works for everyone, so make sure you share any official alerts with others – especially those you know are isolated.

Natural warnings

For a local source tsunami, which could arrive in minutes, there won't be time for an official warning. It is important to recognise the natural warning signs and act quickly.

If you experience:

Out of the ordinary sea behaviour, such as sudden sea level rise or fall and/or an unusual noise.

A strong earthquake that is hard to stand up or lasts longer than a minute.

Don't wait for official warning, evacuate, and wait in a safe place for the official all clear – a wave could arrive within minutes.

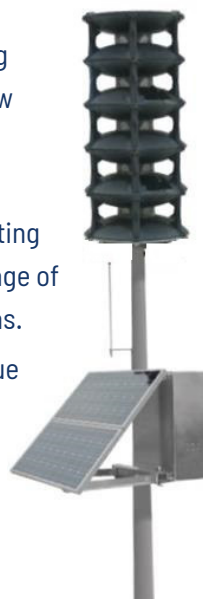

Example of new tsunami siren

What to do when you hear a tsunami siren?

Always remember, tsunami sirens are just one part of a range of formal and informal warning systems, any of which can alert people to a tsunami.

When there is a tsunami warning the siren will sound intermittently. This is a strong signal to

SEEK FURTHER INFORMATION.

Evacuation maps

Find out if you live, work, or play in a tsunami zone so you can plan your evacuation route ahead of time.

Go to www.nrc.govt.nz/tsunami to view our interactive maps.



Current Northland tsunami sirens